

Accord Melisma
Eurorack Module by
SDS Digital & K
Preliminary Guide V 1.1 Jan 2020

I.	Introduction and Naming Conventions	pg. 1
II.	Panel Description	pg. 2
A.	Jacks & Controls	pg. 2
B.	Display	pg. 6
III.	Quick Box Buttons	pg. 7
A.	[RT_PROG:n] Root Progression	pg. 7
B.	[CH_PRG:n] Chord Progression	pg. 7
C.	[●PROG:n ●] Program Selector	pg. 7
D.	[CH_LIST:n] CV Chord List Selector	pg. 7
E.	[LHAND:T=x] Left-Hand Time Attribute	pg. 7
F.	[ZVN=nn] Left-Hand Zero Volt Note	pg. 7
G.	[LHAND:VEL] Left Hand Velocity Offset	pg. 7
H.	[NLOCK=x] Left-Hand Note Lock	pg. 7
I.	[CHORD INSTR:n] Chord Instrument PC Selector	pg. 8
J.	[LHAND INSTR:n] Left-Hand Instrument PC Selector	pg. 8
K.	[ARPEG INSTR:n] Arpeggio Instrument PC Selector	pg. 8
L.	[MIDI CC:x] CC CV Jack Function Selector	pg. 8
M.	[●PUSH] Push MIDI Update Button	pg. 8
N.	[SPREAD Q=x] Spread Quantizer Selector	pg. 8
O.	[IMPRINT:x] CC CV Imprint Mode Selector	pg. 9
P.	[SELECT BUS:n] Select Bus Entry	pg. 9
Q.	[SETTINGS] User Settings and Options	pg. 9
IV.	QB Lists and Menus Descriptions	pg.10
A.	PROGram Settings and Options	pg.10
B.	Root and Chord Progression Lists	pg.11
C.	CV Chord Lists	pg.11
D.	Chord, Spread, MPE, and Velocity Options	pg.12
E.	LHAND Options, Percussa, and Tuning	pg.12
F.	ARP Options	pg.13
G.	CC CV Settings, Functions, Imprint, Sample & Hold, Options	pg.13
H.	PUSH	pg.15
I.	Global Settings and Utilities	pg.15
J.	SysEx for Backup	pg.16
V.	Behind the Panel	pg.18
A.	LINK MIDI & Remote Control	pg.18
B.	SELECT BUS	pg.20
VI.	Theory of Operation	pg.22
VII.	The Chord List & Info	pg.29

I. Introduction and Naming Conventions

Note: This User Guide is preliminary (Jan. 22, 2020) and may change somewhat in the future. Please check <http://www.freshnelly.com/melisma/melisma.htm> for a newer updated version.

Naming Conventions in this guide:

- **"QB"** indicates a **Quick Box on-screen button. Melisma has 17.**
- **"Under the QB"** indicates the menu or list accessed by holding the encoder button down >1 second on a QB
- **[xxx]** indicates displayed text within a QB, while **[nnn]** indicates a number (rather than showing a number)
- **"Encoder"** is the digital rotary knob used to navigate the display UI
- **"Scroll"** is rotation, left or right, of the encoder knob moving the QB cursor or changing a value
- **"Click on"** indicates pressing the encoder button
- **"CV"** Is analog control voltage
- **"Gate"** is a longer pulse, usually defining the length of notes
- **"Trigger"** is a pulse that can have any length with emphasis being on the rising edge
- **"Controls"** may be used interchangeably with "Knobs"
- **"Arp Button"** is the real button beneath the Encoder
- **"PROGram"** is the present PROG:nn (1 of 8) loaded into the Melisma. All user settings reside in each.

Quick Intro!

Thank you for your purchase of the Accord Melisma module by SDS Digital & K!

The Melisma is a multi-purpose way of getting chord action to MIDI synths from your modular system in a simple and intuitive way. Using a handful of triggers and Gates from one of your sequencers, or other CV sources, a musically cohesive method can be realized. The Melisma was designed and built on time tested music rules that can be applied immediately without cumbersome multi-voice sequence composition and timing considerations.

Chord composition is as easy as selecting chords via CV or creating a chord progression to step through at intervals defined by you. The Root notes of the chord can also be directly CV controlled at 1V/Octave or stepped through a progression list. The Root and Chord are entirely separate jacks and controls but can be stepped together in a progression, or one with CV control and the other progressing.

The CV Chord list, different from the Chord Progression List, divides a defined number of chords (from 2 to 61) into the voltage range of 0 to 5 volts. There are 8 slots to create these lists how you see fit. One list can be used different ways by different PROGams by setting the start and end ranges. The progression lists both have the same feature but the start and end point's can be controlled via CV. The range (a window) of selected chord can also be moved around under CV control.

Chords can be strummed, have inversions, have CC envelopes applied at each note, and much more.

Another part of the Melisma is LHAND, which is short for "Left-Hand", and in it's simplest form does what the left hand may do while playing a piano, plays bass notes. Gating LHAND input will play bass notes that musically correspond to the present chord and can have it's own range and MIDI channel. The LHAND jack is multi-faceted though as it also accepts CV to play scales, runs, or trills that align to the chord playing. LHAND can be unlocked to play on it's own at 1V/Octave or just play the melodic 2nd note in any chord. Another LHAND mode called "Percussa" will accumulate changes in the CV at defined divisions and convert them to drum notes to be played on an ACLK trigger. This can satisfy up to 8 drum polyphony and can sound great with simple waveforms like an LFO or even audio from a VCO. Percussive density can be controlled with the accumulation rate, sensitivity, and CV Rate of change making it perfect for an elaborate percussive element that can be repeated with a CV sequence or phased LFO's.

Arpeggiation or burst control of a Chord is as simple as placing a high state on the HOLD jack and triggering the ACLK input to play each note at GATE length. Under CC CV control the note's lengths can be varied in real time, or can trigger recorded MIDI CC envelopes or sample & holds.

MIDI MPE is supported, and is set up to use with any "old school" GM MIDI Synth as well.

The Melisma has such an incredible amount of capabilities it's impossible list them in the introduction, so have a look at the "Theory of Operation" part of this guide for much more!

Enjoy!

Sandy Sims, SDS Digital

II. Panel Description

This section will get you familiar with the Accord Melisma's front panel. For a more in-depth look at each element see the following pages.

→ A. Jacks & Controls

The Melisma has 12 jacks, the black encased are 0.6V to 5V digital, the white encased are CV -5 to +5V, and the diagonal encased is CV and Logic. The Root and Chord jacks can accept logic triggers for progressions. Each knob affects the adjacent jack inside of the same graphic frame, most are attenuators but each changes when the jack isn't patched. The encoder, with built in push button, is to control navigation of the display. The Arp button is to simply select one of 8 Arp patterns, but if held will do an emergency "All Notes Off".

If the display is at the top (i.e. showing the Root/Chord) any control knob movement will be identified and displayed at the very top in a pertinent way.

GATE: 0 to 10V

The Gate input is a low trigger level logic input. It will trigger on a rising edge above 0.6 volts. Any time the Gate is triggered a chord will be played. The chord's note lengths are set by the duration of the pulse on this input. When active the Green LED will illuminate.

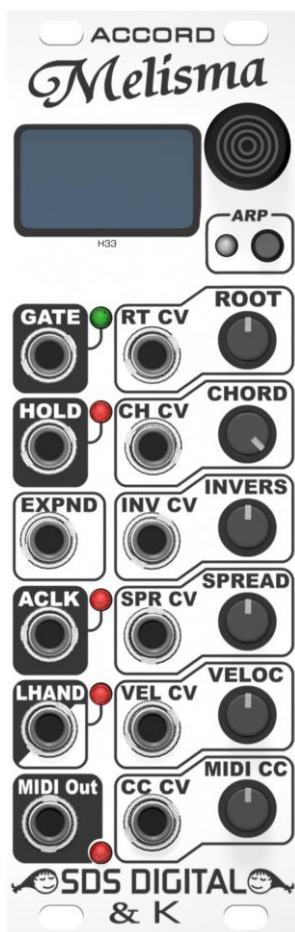

Root CV & Knob: -5 to +5V

The Root CV controls the root of the chord at 1V/Octave that will be sampled at Gate time. With or without the Root jack patched, the knob acts as +/- 24 notes. The Root input is can also accept logic level triggers to step through a Root Progression list. While in Progression mode, the knob continues as an offset.

Chord CV & Knob: 0 to 5V

The Chord CV controls which chord will play from the Root note. The range of the User Chord List sets how many different chords can be accessed by the CV and the knob as an attenuator. The number of chords is divided across the range for CV selection. Moving the knob will display maximum Chord number. The Chord input is can also accept logic level triggers to step through a Chord Progression list. While in Progression mode, the Chord knob is non-functional.

Inversion CV & Knob: 0 to 5V

The range of the inversion (1st, 2nd, 3rd etc) is set by the knob. This range will change with chords so is proportional to the number of notes in a chord. Moving the knob will display the max inversions for the present chord but will change to A 0-100% Attenuator when the jack is patched with a CV.

Spread CV & Knob: 0 to 5V

The Spread knob & CV are on an exponential scale from 0 milliseconds to 2 seconds. This controls how quickly notes in a chord should be played.

The knob acts as a limiter to the CV (but can be seen as an attenuator) with the natural strum spacing displayed. If Spread is quantized, this number will be an upper limit to the quantization so won't reflect the actual timing.

Velocity CV & Knob: 0 to 5V

The Velocity knob without the jack patched is a standard MIDI 0-127 (1-127 really) to control velocity of notes at Gate time and LHAND/Arp notes velocity offsets. When patched the knob is split. The left side acts as a limiter to the CV. The right side acts as an adder to the CV. The velocity has 3 curve settings.

MIDI CC CV & Knob: -5 to +5V

The MIDI CC is a multifunction control for manipulating various MIDI parameters, such as brightness, pan, level, pitch, or even instrument. It can also be set to control internal parameters within the Melisma. Depending on the function set to this control, the top display will show a variety of parameters.

HOLD: 0 to 10V

The Hold input, also a low level trigger level logic input, will stop any Gates from playing chords, but the chords are still registered. While HOLD is set high, ACLK triggers can be then used to play a burst of notes or clocked to play more of an ARPeGGiation. This doesn't mute chords already started so the change-over will flow smoothly.

EXPAND: 0 to 5V

This is a CV input that controls the width of intervals between notes in chords without repeating the Root note. As the notes are additive with the CV voltage, they expand exponentially.

ACLK: 0 to 10V

The ACLK input is a low trigger level logic input that primarily provides a trigger point to step through notes while HOLD input is in the high state. It can also be used for a clock for various other functions, LHAND, Percussa, and MIDI clock output if provided with a constant series of even clocks.

LHAND: -5V to +5V, 0 to 5V

LHAND (AKA Left-Hand) input gate pulses will play Bass notes musically compatible to the present chord. As a CV input, LHAND will play notes at 1V/Octave defined by the scale a present chord represents, melodically defined by the second note of a chord, independently at 1V/Octave, or Poly Percussion, based on the rate of change of the CV input and ACLK timing. The red LED indicator will flash when valid CV change occurs.

MIDI OUT:

This is the MIDI output. It is a TRS (tip=signal, ring=hot, sleeve=ground) that has 25mA MIDI Drive (fan-out of 2 guaranteed) and ring current drive to ground of 50mA for low-draw MIDI devices.

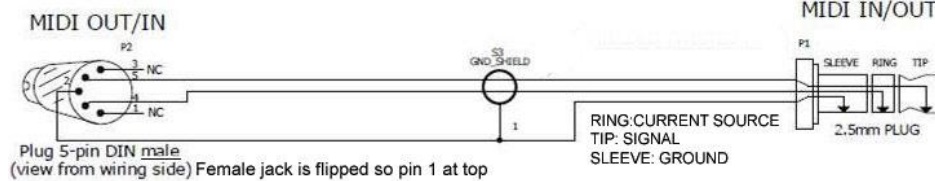

This is MIDI type **A**:
(Akai Pro, IK Multimedia, Korg, Line 6, LittleBits, Make Noise)

Jacks & Controls: In-Depth Description

Here are more in-depth descriptions of the panel interface (where needed)

Root and Chord CV inputs

In Auto Progression Mode these inputs will detect logic inputs and switch to Progression Modes. Root and Chord modes operate independently. The criteria for a logic level signal must be:

- a) A voltage change from <0.25 volts to >4.0 volts
- b) Changed from low to high within 2 milliseconds or so

This may take 2 or 3 pulses before switching modes, but once switched will be responsive instantly.

Switching back to CV Mode to select Chords/Roots requires that a CV be below 4 volts for a few mS and the CV changes don't mimic a logic signal, i.e. 0 to 4V instantly.

To change Root or Chord inputs away from AUTO mode, click and hold on **[PROG:n]** QB 1 second to enter it's menu. ROOT CV PROG:x and CHORD CV PROG:x have options of OFF, ON, and AUTO.

Inversion CV

Inversions are where the first note of a chord is shifted upward. For example a C Maj chord, C E G, in the first inversion would become E G C, C being in the next octave. Musically a 3 note Chord can only have 2 inversions, the second being G, C, E. A 4 note Chord can have 3 inversions, 5 note, 4 inversions and so on.

Because there are 3, 4, 5, 6, and 7 note chords to choose from, the Inversion knob becomes more of a relative position indicator without a CV patched. The displayed number at the very top of the top screen indicates the present inversion as +0 to +6.

With a CV patched to the Inversion Jack, the knob becomes an Attenuator, and the CV operates as a 1 Volt/Octave input. The reason for this is to control the Inversion by comparing it with the next note in the chord (with the Root regarded as 0 volts). If the CV is higher than the next note in the Chord, the Inversion will move to that note.

This solved the problem of divisions over the range and made control a matter of setting the predictable CV at 1V/Oct. Changing the attenuation throws this all off of course!

Spread CV

The Spread CV controls the spacing between each note of a Chord played by GATE input. When the Knob is used alone, Spread displays as milliseconds, but when patched displays as % as this adjustment is mostly done by ear. Spread also has it's own QB [**SPREAD Q=N**] to select quantizing on/off and degrees of data to be applied to a Spread Modifier. If no Modifier has been selected (Default) then only "Y" and "N" will appear.

If Spread Quantizing is turned on, then Spread will attempt to snap to incoming logic stimuli such as ACLK, GATE, LHAND, and Progressions, which can be enabled or disabled under the Spread QB.

Spread Modifiers are Order, Swing, and Random which have 8 degrees of intensity selectable in the Spread Quick-Box.

See [Section IV. D.](#) in QB Lists and Menus for more detail on these options.

Velocity CV

This control is the most straight-forward without a CV patched, 0-127, but with a CV the knob is split. The lower half sets the maximum velocity (displayed as 0-127) and the upper half adds on to the CV input.

When used with a CV, Velocity also has 3 curves of response: Linear, shallow curve, and deep curve as shown below.

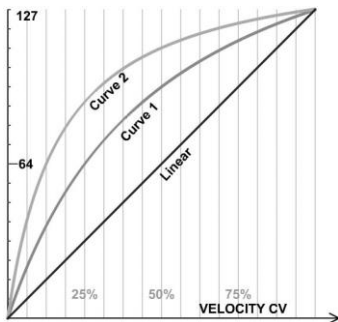

This curve to the CV applies to the knob on either side. i.e.

Knob is just left of center (126 max) and 2.5V is on curve 2 (deepest). This will result in 25% at which point is already quite high (MIDI: 90 of 127)

While if set to linear (none), the same 2.5V would yield only 63, half of 127.

Setting a curve more accurately represents the way audio sound pressure gains occur, more logarithmically, less linearly, thus returning the proportion imagined by half of 5 volts being half the volume as notes are struck.

A linear CV ramp will acoustically sound more linear with curve 1 or 2.

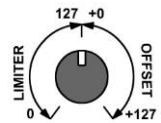

Velocity Curve can be set under the [CHORD INSTR:n] QB.

The velocity is live "per note played" and sets the base for the ARP and LHAND invoked note's velocity offsets.

MIDI CC

This control is the most diverse of the 6 and can be very useful in many ways. Primarily it is a MIDI control changer alone, and an attenuator to a CV input → MIDI control change, but can be changed to be any one of the follow MIDI and internal controls:

CC	RPN & NRPN CC# from 0-127 (CC#10: Pan is Bi-Polar so uses attenuvertor)
AFT TOUCH	MIDI After-touch control
PC (INSTR)	Change GM MIDI instruments 1 to 128 (PC: Has a 10mS block after change)
PITCH BEND	Display shows set range with knob i.e. +/- 0 to 1200 cents for range 12 semis (Bi-Polar)
CH PROG LOW	Sets low limit of Chord progression, range 0 to high limit-1
CH PROG HI	Sets high limit of Chord progression range lower +1 to 31
CH PROG WIN	Windows set Chord Progression range from zero up to max range
RT PROG LOW	Sets low limit of Root progression, range 0 to high limit-1
RT PROG HI	Sets high limit of Root progression range lower +1 to 31
RT PROG WIN	Windows set Root Progression range from zero up to max range
LHAND_T	User Time setting 20-250mS
ARP SELECT	Select an Arp/Burst Order 1-8 (same as the button)
ARP GATE	0% (pauses Arp) to 200% of Gate length
SPRD MODIFY	1-8, any of the Spread Modifier's data
CC SELBUS	Select Bus 1-64,1-32,1-16,1-8,1-4 evenly distributed
PROG RESET	This one has an entry under the [PROG:n] QB for Progression Reset Methods

The CC CV Function setting can be accessed under the [**MIDI CC:x**] QB. See [Section IV. G.](#)

LHAND

As mentioned on the previous page, LHAND is a versatile companion to simply creating MIDI Chords with gates and CV's. With a simple gate it can play a pleasing Bass line along with the chords on a different MIDI channel, play a melody that snaps to the Chords, produce runs of scaled notes at any time, be completely autonomous to the Chords with 1V/Octave precision, or even become a percussion controller.

LHAND CV input can play on it's own at 1V/Octave if the CV changes more than the set minimum sensitivity measured in cents/millisecond. This can be set under the [LHAND INSTR:n] QB. There are positive safeguards in place to prevent an LFO CV input from sending 500 notes/second in the form of latching to a selected timebase from Gate, ACLK, or a user set value from 20-250 milliseconds. This also helps keep a random LHAND CV in sync with another element.

Gating LHAND with a logic level plays Bass notes that follow the chord according to music rules and requires no timing except pulse width for the bass note's lengths. For more detail on LHAND and it's modes of operation see [Section IV. E. LHAND...](#)

EXPAND

The Expand CV has no attenuator or settings, but is very influential when playing Chords. As the CV increases notes are spread out to new positions conforming to the rule that the Root never repeats. The size of the chord directly corresponds to the number of "skips" possible as shown below.

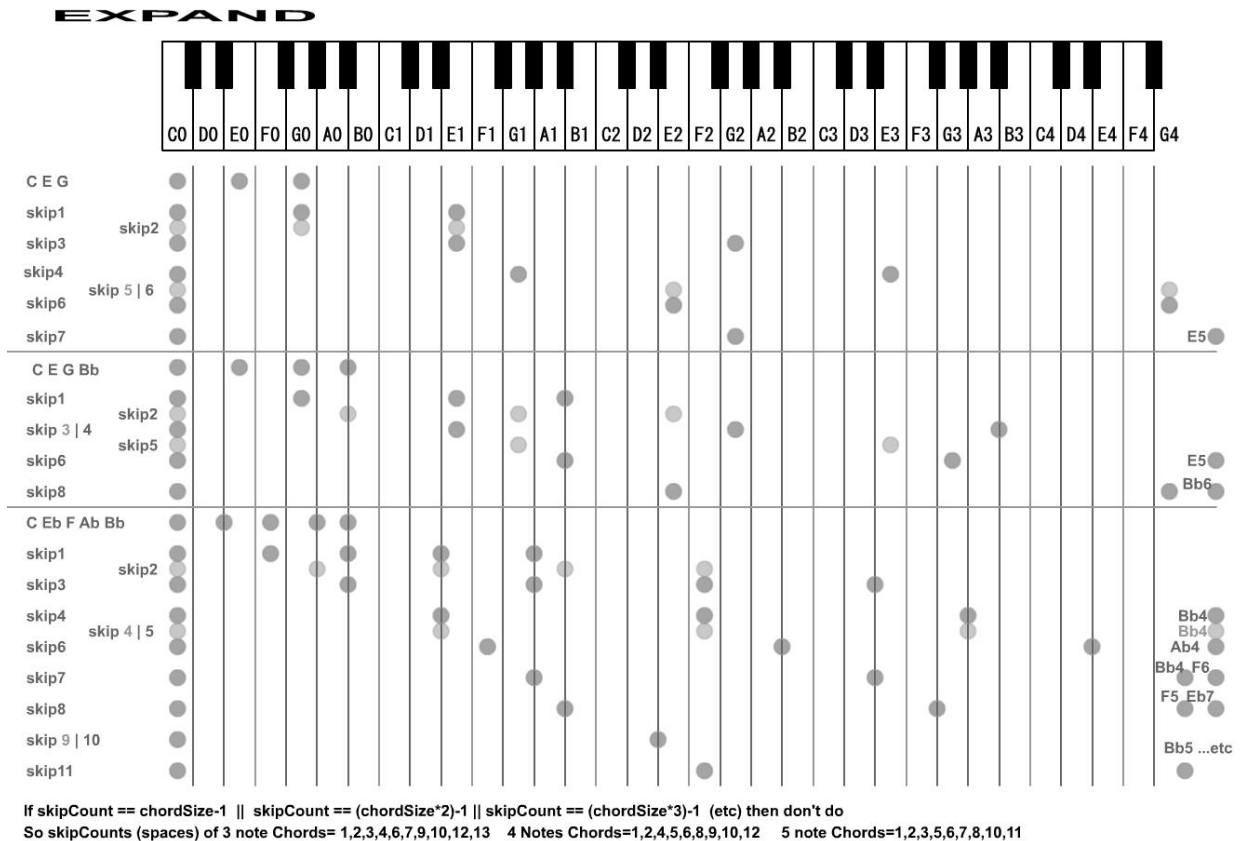

Smaller chords have less notes within an octave so tend to Expand more rapidly. The clusters of notes shown simply go beyond the example's unrealistically low keyboard range but still conform to the rule. The purpose of this feature is to add "sparkle" to a Melisma composition and is best described by just trying it out yourself!

HOLD, ACLK, and ARP

When HOLD is held high, Chord notes can only be played by pulsing/triggering the ACLK input. This offers the ability to play bursts of notes or clocked notes as an Arpeggiation. As GATE's can still register new Roots and Chords, the Arp's will change smoothly from one to the next without resetting while HOLD is... held.

ARP Button

The Small Arp Button selects one of 8 arpeggio orders as shown below. The top of display space will indicate by name the type of Arp you have selected and the bi-color LED changes as shown:

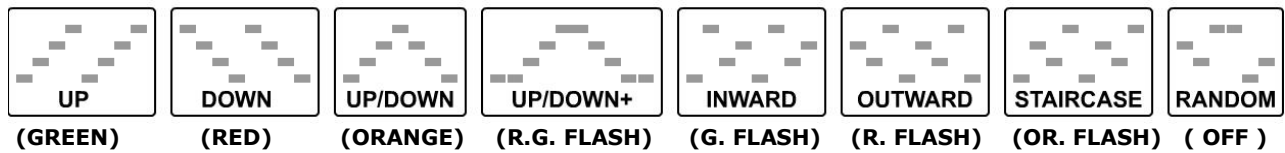

As with all Arp's, chords of different sizes will take different numbers of steps to traverse a cycle and this has always been something to consider when patching as you are likely already aware.

As ARP or Bursts of notes only occurs when HOLD is held high and ACLK input has triggers, and releasing HOLD will reset the ARP start step, a quick release between steps can accommodate desired resets after X number of notes with HOLD and ACLK resuming simultaneously.

* Feature: *Holding The Arp button for >2 seconds will send an emergency "All Notes Off"*

There is also a CC CV Arp Gate that sets duration of Arp notes but also pauses without reset. If the ACLK is a constant series of pulses, notes can be shortened or paused with the same CV.

→ B. Display

The Display and it's 17 Quick-Box Buttons makes the Accord Melisma capable of so much in such a small HP. The top-left displays the last Root and Chord, while the top right displays the last moved control knob.

Below this area are the QB's. The QB's can be accessed by scrolling up/down like a website page. The cursor position is shown with braces on each side of the selected QB.

Clicking on any QB will select it's present parameter for modification which is hi-lighted by white box.

(except the **[PUSH]** and **[SETTINGS]** QB's). Clicking again will exit the parameter back to the page.

Clicking and Holding for over 1 second will open the list or options menu related to the selected QB.

Clicking and holding when within a menu or list will save / exit the menu back to the QB page.

Scrolling to the top of the page and clicking will invoke the Screen-saver piano roll display. This will begin after 30 second automatically to protect the screen but if there are no notes playing "fake" notes will appear so the module looks on. Superimposed with the notes is a graphic representation of the CC CV input.

Keyboard Display

To view a keyboard-like display of notes as they are being played, go to the top of page then select QB's row one down so the large Root and Chord display are chopped in half. After a few seconds the keyboard will pop up. QB's can still be selected while the keyboard is up. Moving down beyond this area of the page, or back to the top will remove the keyboard. Warning: While the keyboard is shown the screen saver will not become active. If you're wondering why this is an issue, see below.

Screen Saver

After 30 seconds of no knob movement or CV jack (patching/unplugging) the display will turn into a piano-roll styled screen saver with the CC CV input indicated as a graphic plot overlay, which is useful.

Many people don't know that OLED displays will burn in over time (just like CRT monitors of old) so should have constantly moving graphics when on for long periods. (The "O" in OLED stands for "Organic" thus, like the rest of us organics, has a life span!)

If there are no notes being played onto the piano roll, then "fake" notes will appear to indicate the module is operational. I personally have come to enjoy watching notes appear as they play, and the CC CV track has been quite useful for checking out LFO combinations etc. It has a low sample rate but is sufficient for that.

If you don't want to wait the 30 seconds the screen saver can be forced by simply scrolling to the top of the page (above all QB's) and clicking. If you want to stop the Screen saver from happening, select a QB. The screen saver won't start while something is selcted (of course).

There is also a screen on/off setting but that just stops the piano roll, the displayed screen will scroll across continuously showing the last settings. (This may be changed in the future to some other types)

III. Quick Box Buttons

Each Quick-Box (QB) has a specific function to control and/or display related data. The QB's make a small module into a large one by offering quick access to anything that will/may need to be manipulated during a performance. Hi-lighting any field within a QB will hold off entry into the Screen saver. Here is a brief listing of all 17 QB's...

→ A. [RT_PROG:n] Root Progression

Displays the present last step in a progression of Roots whether underway or not. Clicking on this QB will allow selection of the next start point increment or step. Thus selecting 1 will set for next step to be 2. The range allowed is limited by the Root progression start/end limits which can be set under this QB.

→ B. [CH_PRG:n] Chord Progression

Displays the present last step in a progression of Chordss whether underway or not. Clicking on this QB will allow selection of the next start point increment or step. Thus selecting 1 will set for next step to be 2. The range allowed is limited by the Chord progression start/end limits which can be set under this QB.

→ C. [●PROG:n ●] Program Selector

This QB displays the present PROGRAM#. The Melisma has 8 slots for PROGRAMS AKA presets. All but Global settings is saved & loaded within the PROG#. Click this QB to select a different PROGRAM#. Each PROG# has it's own set of Root & Chord Progression lists, but shares the CV Chord Lists.

→ D. [CH_LIST:n] CV Chord List Selector

This QB displays the currently used Chord List from 1 to 8 and "ALL" chords. The same Chord lists are used by all PROGRAMS but the Start/End ranges can be unique to each PROGRAM#. Chords can be added, deleted, inserted, or modified, along with start & end ranges by clicking and holding this QB. (See [section IV.C.](#))

→ E. [LHAND:T=x] Left-Hand Time Attribute

This QB displays the timing selection for LHAND quantizing. The selections ACLK1-4, GATE1-4, and 100mS can be changed by clicking on this QB and selecting. To change the user Time in milliseconds, first select "100mS" then click again to change the value from 20mS to 250mS. Clicking and holding on this and the next 3 QB's will enter the LHAND settings menu (See [section IV.E.](#))

→ F. [ZVN=nn] Left-Hand Zero Volt Note

This QB displays the LHAND note that will be set @0 volts on the LHAND CV jack. It allows for any note from 0-99 and does not snap to octaves. Note that this only affects LHAND CV, not LHAND gated Bass Notes, which has it's own setting in the LHAND menu.

→ G. [LHAND:VEL] Left Hand Velocity Offset

This QB shows the Velocity offset for LHAND. This can be +/- 0 to 99 and offsets in real time from the Velocity CV input and Velocity knob result. (simply put, the Chord's velocity).

→ H. [NLOCK=x] Left-Hand Note Lock

This QB displays the type of LHAND CV notes will be played. "Y", or simply yes, indicates LHAND is restricted by a scale produced by the present chord and root. "M", or melody, indicates LHAND is limited to melodic notes, the 2nd note in current chord and root. "N", or no, means there is no quantization and LHAND is free to play any note at 1V/Octave. This QB has no affect on playing LHAND Gated Bass notes.

→ I. [CHORD INSTR:n] Chord Instrument PC Selector

This QB simply chooses an instrument (Program Change) to set on the Chord channel(s) from 1-128. Standard GM instrument names are displayed as a pop-up when the QB is selected which aide in selection if using a GM MIDI synth, or a reference when not. Under this QB is Chords Channel, Velocity curve, and MPE (Multi-dimensional Polyphonic Expression) mode selection. (See [section IV. D.](#))

→ J. [LHAND INSTR:n] Left-Hand Instrument PC Selector

This QB also selects an instrument, but for use by the LHAND functions from 1-128. Note that this instrument must be set on a different MIDI channel than Chords or Arp or you would just change the Chords instrument. By factory default, the assigned MIDI channel for LHAND is 12. This makes room for possible MPE mode and percussion. If LHAND is switched to Percussa mode, the default channel becomes 10. (Shown in brackets) Holding 1 second on this QB will access MIDI channel and finer settings for LHAND. (See [section IV. E](#))

→ K. [ARPEG INSTR:n] Arpeggio Instrument PC Selector

This QB selects an instrument to be used when HOLD input goes high and ACLK triggers arpeggios or bursts of notes. Again, this should reside on a different channel than Chords or LHAND. If not, then leave the instrument the same as Chords intrument. The default channel for Arping is channel 13. Holding 1 second on this QB will access MIDI channel, velocity offset, and ACLK→MIDI. (See [section IV .F.](#))

→ L. [MIDI CC:x] CC CV Jack Function Selector

The MIDI CC QB displays either the CC# that the CC CV input will manipulate, or the function of CC CV. Clicking on this QB will display CC#0 to 127, Pitch Bend, Aftertouch, and PC (program change) for MIDI that will be sent by the CC CV and knob. Beyond that are several internal control options to select from.

See [Jacks and Controls: In Depth Description](#) on [page 3](#) for a list of the functions.

Clicking and holding the MIDI CC QB will open the configurations for CC Channel, Function, CC#, Sample & Hold option, Bend range, and bend 1V/Oct option, along with LINK CC remote control setups.

→ M. [●PUSH] Push MIDI Update Button

The PUSH QB is a momentary button that will send a ton of MIDI data with all settings in the present PROGram#. It can be used to sync a newly added/powered up synth or MIDI hardware to the Melisma's settings, or reset assigned CC's to prescribed values. (There are 4 of them plus vitals like CC7 & 10, Bend) Clicking and holding this QB will enter into the PUSH menu where Push CC's can be set, along with options. See [section IV. H.](#) PUSH for more.

→ N. [SPREAD Q=x] Spread Quantizer Selector

The Spread QB selects primarily Quantizing Yes/No. The time between chord notes is the parameter of spread. The quantizing can be affixed to Progression triggers, ACLK triggers, LHAND_Time, or Gate rising edges. By default all of these are turned on. They can be turned off by click and hold to enter the Spread Q menu and disabling the ones you don't want. This is per PROGram (not Global) so will only apply within this PROG#.

In the menu there is a selection for Spread Modifier that applies swing, changes notes order, and adds a random variant. When any modifier is selected, the [SPREAD Q=x] QB will also select 1-8 for intensity of the modifier. The modifiers work whether or not quantizing is on so to turn on quantizing, first scroll CW to "Y" then set the intensity 1-8, to turn off quantizing scroll CCW to "N" then select intensity 1-8. See [section IV. D.](#) for more in-depth look at how to use Spread modifiers.

→ O. [IMPRINT:x] CC CV Imprint Mode Selector

This QB turns IMPRINT CC envelope recorder on/off. Imprint, when on, will record the CC CV during a high state of the Gate input. Gate also determines the note's duration in most cases so the envelope's will match. Imprint assigned events, such as Chord notes (Gate), Root & Chord Progression triggered notes, Arp notes, and LHAND notes, will trigger the recorded envelopes to play as the CC CV would normally at the time of recording.

A previous envelope may still be applied to notes Spread out while a new one is recording or playing. This envelope can be assigned, as usual, to the CC CV MIDI setting CC#0-127, Pitch Bend, After touch, or even PC (instrument). In MPE mode the chord envelopes are all on separate channels so are quite striking and modular-like! Click and Hold this QB to enter the Imprint options and see [section IV. G.](#) for more on Imprint.

→ P. [SELECT BUS:n] Select Bus Entry

If Melisma is set to be Master or AUTO on Select Bus:

This QB can send Select Bus State/Preset messages when clicked, then clicked again to exit. If this QB is clicked to hi-light the State number (turn encoder to change) then clicked and held for >1 second it will send a State/Preset Store message to other modules.

Clicking this QB when in AUTO sets Melisma as Master. Any valid State message received will turn Melisma back into a Slave. "Valid" means a State/Preset# that is assigned within Melisma.

If the Melisma is set to be a Slave:

This QB can only be used to enter the Select Bus (click and hold >1 second). There the Slave State number (or address really!) can be changed. See [Section V. B.](#) for more on Select Bus.

→ Q. [SETTINGS] User Settings and Options

When clicked this QB does nothing. Clicking and Holding for >1 second will open the Settings Menu. This menu is covered in detail in [Section IV. I.](#) Please read before changing settings here.

IV. QB Lists and Menu Descriptions

Most settings in the Melisma apply to the present PROGRAM# and are loaded upon entry to a new PROGRAM#. Some are specific to certain purposes while others will affect the way the whole module behaves. It's best to familiarize yourself with these settings, or at least to know they exist to get the full value out of your Melisma.

To get "under" a Quick-Box, press and hold for >1 second. To exit out of a list or menu, do the same.

→ A. PROGRAM Settings and Options

The Melisma can store up to 8 distinct Presets we call PROGRAMS. "PROG" is in caps as that's what you see on the display screen. *PROG:1*. Each PROGRAM has it's own settings for everything except Global settings. The CV CHORD Lists are shared by all PROGRAMS, while the ROOT and CHORD Progression lists, displayed as **[RT_PROG:nn]** and **[CH_PRG:nn]**, are unique to every PROGRAM.

Select the PROG QB then press and hold encoder down for >1 second to enter the PROG menu

The following list will appear:

PRG:SONG NAME # 1 The name of this PROGRAM (16 characters)
ROOT CV PROG: x Root Progressions enable. OFF, ON, AUTO
CHORD CV PROG: x Chord Progressions enable. OFF, ON, AUTO
LISTS FROM LINK: x Receive Lists from Sequarallel module (or other Accord Series)
COPY PROG:1 TO:2 Will copy this PROGRAM to another 1-8
PROG RESET: CC CV Selects an input source to reset Progressions

Song name

Any name can be entered as this is for your reference and will be sent if a SysEx backup is made

This name will show under the QB when PROGRAMS are scrolled through.

To change letters is the old-school method. Click to start editing, scroll to the letter you wish to edit, click to edit and scroll the characters, click to exit and edit another letter. To exit, scroll to the right beyond the end.

Root and Chord progressions enable/disable

For the most part you can leave these in AUTO unless you are having problems with the type of CV's you want to input resembling logic signals. (0 to 4V in < 2 mS) This will cause an entry into Progression mode.

Once the mode has switched to progressions, the CV must fall below 4 volts for >4mS before it is considered a CV again.

Inversely, if your logic level signals are too slow (slew-ish) then CV mode might be switched to accidentally. It takes a couple of seconds for Melisma to stabilize into a progression again, so would appear to be skipping progression steps, or not stepping at all.

Lists From LINK

This is a feature that receives proprietary SysEx data via the LINK or Select Bus to create temporary progression and CV Chord lists to use with a loaded sequence. It is specifically for hardware and will be featured in the Accord Sequarallel release documentation.

Copy PROGRAMS

This feature has been included to copy one PROGRAM to another to create a variation. Make sure you are "in" the PROGRAM# you wish to clone, then select (carefully) where you want the duplicate to be.

Once clicked, a prompt "Are you Sure?" will appear. You have 5 seconds to click again or it will reset.

After exiting the menu you will notice that you are already in the duplicated PROGRAM. Edit away!

Progression Reset source

As there is no "reset" jack for Root and Chord progressions, this option will assign any one of several methods to invoke a Progression reset back to the low limit. Here they are:

Reset Type:	Resets-	Method:
CC CV	Both	CC CV function must be set to "PRG_R" to use CC CV input for reset
HOLD	Both	Low to high transition on HOLD jack will reset
GATE	Both	Low to high transition on GATE jack will reset
ACLK	Both	Low to high transition on ACLK jack will reset
TIME 1,2,5 seconds	Either	No trigger to Root/Chord CV jack for x seconds will reset
TIME 2X, 4X last	Either	No trigger to Root/Chord CV jack for 2x or 4x the last interval will reset
HIGH > 2X last	Either	Trigger pulse width is >2 times the duration of last

→ B. Root and Chord Progression Lists

Under the **[RT_PROG:0]** and **[CH_PROG:0]** QB's are the progression lists editors.

* Each list can be up to 32 steps long. Empty steps will play the previous valid Root or Chord.

Root Progression list

Upon holding encoder on **[RT_PROG:0]** the Root list will appear as below. Root notes are semitones followed by the octave. On the right are the Chords that are in the same position in the Chord progression list. They are for reference only.



Scroll up/down to point the arrow at the Root note you would like to edit, or-
Scroll the arrow between Root notes to insert, or-
Scroll to a spot marked "---" to add a new root note to the progression, or-
Scroll to the point you wish to place a "PAUSE", or-
Scroll to the point you wish to be lower or upper progression limit.
(Indicated by bar on the left side)

Click to open the Root notes window (will open on the right side), then with:

Editing, adding, inserting notes: Select a Root note and click to place it into the list.

Clearing a note: Scroll down the opened window to "--CLEAR--" and click on it. This will leave a space

Deleting a note: Scroll down the opened window to "--DELETE--" and click on it. This deletes note, fills spot

Setting Hi/Low limits: Scroll down the opened window to "SET LO" or "SET HI" and click on it

Inserting a Pause: Scroll down the opened window to "PPAUSE" and click on it

* **Pauses** are a special feature that will wait for the other progression to also reach a pause marker before continuing. This can create a logical but longer sequence from a relatively small number of steps. Both Root and Chord Progressions must be underway (i.e. not a CV controlled chord) for pauses to work. See Progressions ([page 27](#) in Section VI. Theory of Operation)

Chord Progression list

Upon holding encoder on **[CH_PROG:0]** the Chord Progression list will appear as below. On the right are the Roots that are in the same position in the Root progression list. They are for reference only.



Scroll up/down to point the arrow at the Chord you would like to edit, or-
Scroll the arrow between Chords to insert, or-
Scroll to a spot marked "---" to add a new chord to the progression, or-
Scroll to the point you wish to place a "PAUSE", or-
Scroll to the point you wish to be lower or upper progression limit.
(Indicated by bar on the left side)

Click to open the Main Chords Selector window (opens on the right side), with:

Editing, adding, inserting notes: Select a Chord and click to place it into the list.

Clearing a chord: Scroll down the opened window to "--CLEAR--" and click on it. This will leave a space

Deleting a chord: Scroll down the opened window to "--DELETE--" and click on it to delete chord. Fills spot.

Setting Hi/Low limits: Scroll down the opened window to "SET LO" or "SET HI" and click on it

Inserting a Pause: Scroll down the opened window to "PPAUSE" and click on it

→ C. CV Chord Lists

The CV Chord List, or just Chord List is edited in exactly the same way as Chord Progression List above, with the exceptions that there are no Pauses, and there can be up to 64 chords in each list.(0 - 63)

There are 8 chord lists that can be shared by each PROGRAM, but can be organized as PROGRAM#1 uses Chord list 0, PROGRAM#2 uses Chord list 1 etc. however you prefer.

The lower and upper limits that the Chord knob and CV can access is unique to each PROGRAM though.

So, in theory, the same Chord list loaded with all of your favorites could be used by 3 different PROGRAMs, each with different lower and upper limits. Chords can be repeated as often as you like!

If there is a Gate trigger present while the Chord Selector window and you are selecting a Chord to add, the chord will be heard as you select through them, so you can choose by ear if you're unfamiliar with them.

→ D. Chord, Spread, MPE, and Velocity Options

Chord related options/settings are in menus behind the **[CHORD INSTR:nnn]** and **[SPREAD Q=x]** Quick-Boxes. Press and Hold on Chord Instrument QB to access:

CHORD CHAN:1 This is the Channel Chords will play on.
VELOCITY CURVE:x This sets the Velocity curve, linear, Mid, or Deep (see [page 4](#) for graphic of curves)
M.P.E. Mode: Y/N This turns on MPE (Multi-dimensional Polyphonic Expression).

* MPE

MPE requires that the Chord Channel be set to 1 as this will be the master channel for zone 1. Melisma sets the zone range to 7 (channel 2 through 8) as there are 7 possible notes in a chord. MIDI channels past 8 can be used freely.

Melisma sends proper MPE messages for an MPE enabled synth, but can be used with a regular GM synth that is capable of 8 channels having any instrument (PC) assigned to them. Melisma manages the dispersal of notes on it's own terms to achieve per note expression using Imprint CC CV mode and CC Sample & Hold. CC or Pitch Bend information is sent to all of these channels individually when MPE is active.

With MPE it's a good idea to set the CC CV MIDI channel to 1 also. This way CC CV modes like Imprint and Sample & Hold will send their data to the zone master channel which will internally cause CC's to be sent to each channel in the zone. The CC data in Imprint and S&H is on a "per note" basis as opposed to all channels together. Melisma only supports MPE Zone 1.

→ E. LHAND Options and Tuning

LHAND (left-Hand) is probably the most wonderful and chaotic part of the Melisma. Thus it's worth checking out how it works in *section VI. Theory of Operation*. Here we'll just blindly go over the LHAND settings. The first LHAND related menu is under any of the upper 4 LHAND QB's. Click and hold on any of these 4 to enter the same menu. Here are the menu items and a quick description:

LHAND CHAN: n LHAND MIDI Channel. Changes to PERC CHAN when Percussa is turned on.
LHAND VEL:n LHAND Velocity Offset (from Chord Velocity) +/-0 to 99
LHAND CV:x Set fixed jack function. CV MELODY, TRIG BASS, or AUTO (default). (See 1 below)
LHAND BASS OCT:n Sets Bass Gate Octave offset from -1 to + 4 octaves.
LHAND PERCUSSA:Y/N Percussion mode enable. Default channel is 10 (see 2 below)

The second menu is under the **[LHAND INSTR:nnn]** Quick Box, with settings as follows:

LHAND CHAN: n LHAND MIDI Channel. Shows Percussa channel is brackets (10) if on
LHAND SENS: n c/mS This sets the rate of change sensitivity for LHAND (see 3 below)
LHAND EDGE: n Cents This shifts the 1V/Octave centering up or down by up to 100 cents. (see 4 next page)

1. LHAND Jack Function

Normally you'll want to leave this in AUTO mode as generally it's trouble free, but there is the option for only CV or TRIG BASS, which Locks LHAND to only play bass notes. "TRIG" is an intentional misnomer as GATE is associated with the GATE input. This avoids confusion. Triggers *can* be used but longer pulses will play longer bass notes of course.

2. Percussa

Percussa mode is similar to LHAND in that it samples CV's and, if there's enough change, will play notes. In this case it's percussive notes. The difference is notes are accumulated every tick of the selected LHAND time base then played all at once on the rising edge of ACLK. Unlike LHAND though, ACLK is required. Selecting the Percussa MIDI channel requires that Percussa be first set to "Yes", then the LHAND CHAN:n will change to LHAND PERC CHAN:10, at which point it can be edited. Channel 10 is standard for GM sound set. See [Section VI. Theory of Operation](#) to learn more about Percussa

3. LHAND Sensitivity

This setting adjusts the amount the CV must move from the last time frame in Cents/millisecond from 10 to 300 cents (about 3 semitones). If set too low, noise may trigger notes, whereas setting too high will skip transitions of < 1 semitone. It also depends on the slew/motion rate of your source, sequencer, or LFO. This is a great drum density control for Percussa mode. The factory setting is 80 C/mS.

4. LHAND Edge

This is a Fine Tune for LHAND. Adjust upward if notes are too low, or downward if notes are too high. The number is in Cents, 1/100th's of a semitone. If your source (quantized...) CV is producing notes that are too low, then adjust towards the + side, likewise if the notes are too high, adjust to the - side.

→ F. ARP Options

The HOLD→Arpeggio/burst mode has 3 settings under the [ARPEG INSTR:nnn] QB:

- ARPING CHAN:13 This sets the channel for Arp/burst. This can be any MIDI channel 1-16
- ARP VELOCITY:0 Velocity offset to main (chord) velocity +/-99.
- ACLK→MIDI:YES This turns on (stable) ACLK to MIDI output. (See below)

ACLK → MIDI Clock

When this option is enabled and there is a relatively even clock signal presented to the ACLK jack, a 24 ppqn MIDI Clock will be sent. This aides in MIDI synth Delay or Key Arp's synchronization with the modular rig. ACLK→MIDI Clock can also be sent out over the LINK header (See IV. I. Global Settings and Utilities)

* Note that to pass MIDI clock through Melisma from LINK, this feature must be turned off.

TIP:

CC CV input jack's function can be set to control Arp Note lengths (ARP_G) relative to the Gate duration/Chord Note lengths from 1% to 200%. If zeroed this CC function will pause the Arpeggiation without losing it's place contrary to the HOLD input falling low which will reset the Arp Step to 1.

→ G. CC CV Settings, Functions, Imprint, Sample & Hold, Options

The number of CC CV Functions make this probably the most versatile jack on the Melisma. As lightly covered on page 4, the CC jack can be assigned one of 16 different functions. The namesake, MIDI CC controller, is of course the first function. This can be selected by default by choosing any "number" in the [MIDI CC:n] QB. All of the other Functions (in abbreviated form) can be selected from the QB as well, but the original CC# will remain as the last selected parameter. This can be viewed under the QB in the MIDI CC menu. As the longer form names have been covered on page 4, I'll list them as they appear in the QB parameter.

CC CV Functions

- MIDI CC:0-127 Any NRPN/RPN MIDI CC#. CV will send MIDI value 0-127
All CC's will display at top of display page as 0-127 except for Pan (#10) which is a bipolar control so shows -/+ 0 to 63 left through right
- MIDI CC:AFT. This is the After Touch. CV will send 0-127
- MIDI CC:P.C. This will send a program change 1-128.
To limit fast instrument changes, there is a 100mS minimum update time after first.
- MIDI CC:PBEND This will send a Pitch Bend (PW) message +/- 0 to 8191. This makes the control & CV bipolar +/- 5V. Depending on the Bend Range selected, the Knob Display may show +/-100 Cents to +/-1200 Cents. The knob acts as an Attenuvertor for Pitch Bend.
- MIDI CC:C_LOW Internal Control: Sets low limit of Chord progression, range 0 to high limit-1
- MIDI CC:C_HI Internal Control: Sets high limit of Chord progression, range low limit +1 to 31
- MIDI CC:C_WIN Internal Control: Moves Set Chord Range window from 0 up to top end of range at 31
- MIDI CC:R_LOW Internal Control: Sets low limit of Root progression, range 0 to high limit-1
- MIDI CC:R_HI Internal Control: Sets high limit of Root progression, range low limit +1 to 31
- MIDI CC:R_WIN Internal Control: Moves Set Root Range window from 0 up to top end of range at 31
These ranges will be indicated at the top of page when the CC control knob is moved and the Chord or Root Progression QB's will reflect the CV modified steps when in view.

USER ROOT PRG LIST:1

0	:C3	Maj	
1	:E3	Maj7	
2	:G3	min	
3	:E3	min7	
4	:Ab3	Maj	
5	:G3	Maj7	
6	:F3	min	
7	:E3	min6	
8	:C3	sus2,4	
9	:G3	min	
10	:F3	7	
12	:G3	Maj9	
13	:C4	dim7	
14	:D4	min6	
15	:Eb4	7,9	
16	:F4	min	
17	:G4	---	
18	:C5	---	

Changing these parameters while stepping through a progression:

C/R LOW

Low range changes will only be "seen" when the progression resets.

C/R HI

High range change below present step will cause next to reset to Low.

C/R WIN

A range window moved above the present step will allow continuation.

A range window moved below the present step will cause next step to the present window location's lower range.

MIDI CC:HANDT Internal Control: Sets the LHAND user Time parameter value from 20 to 250 milliseconds. This parameter must be Selected in the QB, i.e. [**HAND_T:100ms**]

MIDI CC:ARP_S Internal Control: Selects Arp Step Order 1 -8. Arp R/G LED will indicate change. The CC CV knob (attenuator to CV) will be displayed at top of page as 1 to 8 as is Arp.

MIDI CC:ARP_G Internal Control: Sets Arp Note length from 1% to 200% of last GATE duration. If falls to 0% the Arp steps will be paused (ACLK disconnected) without resetting. Pause state is displayed at top of page. CV is 0 to 5 Volts. CC Knob is Attenuator.

MIDI CC:SPR_M Internal Control: Selects Spread Modifier Intensity 1-8. If there is a Spread modifier set, SWING, ORDER, RANDOM, then will be applied immediately. Knob acts as Attenuator.

MIDI CC:S-BUS Select Bus Control: Selects a Select Bus State/Preset to send. Range depends on setting under [**SELECT BUS:n**] QB 1-4 to 1-64. Range is divided equally over these ranges.
* Note that Melisma must be set as a Master, or AUTO but in master status to send.

MIDI CC:PRG_R Internal Control: Resets both Root & Chord Progressions to next step to low limit. Top of page displays Reset/Off when not patched so knob can manually reset, and when patched displays trigger voltage required. CV transition to > Knob voltage triggers reset. This Progression Reset can be used regardless of PROG RESET setting.

CC CV: Sample & Hold

CC Sample & Hold can be turned on under the [MIDI CC:x] and offers an alternate method of applying the MIDI control changes (CC), After-touch, Pitch Bend, and PC. When enabled, at the time of a Note the CC CV is sampled and this single value is sent just before the note on message.

CC Channel must be set to the same channel as the notes are being sent on, or, if MPE mode is on, channel 1.

CC CV: IMPRINT

As mentioned on page 9, IMPRINT samples the CC CV jack only during a high state on the Gate input. If using Progressions or Arping, a single Gate can set all following note lengths and record an envelope. Every note played afterwards will have the same length and CC envelope applied.

If the Chord Spread is long and a new Gate happens while "old" notes are still queued, the previous envelope is retained for those while the new envelope will be applied to the new notes. The only limit to the number of envelopes possible is the 10 second total sample time maximum.

Under the [IMPRINT:Y] QB there are options for which notes will trigger an envelope to play:

TRIG BY GATE:Y	Any Gate induced notes, Chord notes, will start an envelope play
TRIG BY R/C PRG:Y	Either Root or Chord Progression notes will start an envelope play
TRIG BY ARP/ACLK:Y	Arp Notes will start an envelope play
TRIG BY LHAND:Y	LHAND notes will start and envelope play

IMPRINT, when turned on, will override CC Sample & Hold mode and only sends MIDI CC, After-touch, Pitch Bend, and Program Change MIDI messages. Internal CC CV control function selections will operate directly and ignore the IMPRINT state.

CC LINK Remote Control

While LINK MIDI input is discussed in the following Section V, I thought it wise to mention here as it does pertain to assigned CC CV functions. MIDI remote CC's (user-set CC#'s) can control some of the functions listed in this section. There is no guard against the two entities controlling the same function so they may contradict and fight each other. The possible conflicts are:

MIDI CC:ARP_S	LINK REMOTE: ARP TYPE
MIDI CC:SPR_M	LINK REMOTE: SPREAD MOD

→ H. PUSH

The **[*PUSH]** QB is a momentary button that will send specific MIDI messages to sync the state of the Melisma with a connected MIDI synth. For example, you have connected a synth and , rather than changing the PROGram to send loaded settings to the synth, PUSH can be pressed instead. Under the **[*PUSH]** QB are settings to send 4 custom MIDI CC updates. This might be useful for setting a CC like #71 (resonance in some synths) to a certain value as the CC CV is set to control CC#74 (cut).

Other messages sent, "Vitals" are All channels Volume(CC#7=127), Pan(CC#10=centered), Sustain Pedal Off (CC#66=0), damper pedal(CC#64=0), and Pitch Bend set to center. Chord, Arp, and LHAND PC (instruments) are also sent.

Looking under the **[*PUSH]** QB (same method click and hold > 1 second) you'll find the following:

PUSH CC:--- TO:--- Click on these to select a CC to PUSH, then click again to set the value
PUSH CC:--- TO:--- Once value is set, click once more to return to the selector arrow
PUSH CC:--- TO:---
PUSH CC:--- TO:---
PUSH CC VITAL:YES PUSH will send the "Vital" updates as mentioned above
PUSH LHAND+ARP? PUSH will update LHAND and ARP Channels

With MPE mode turned on, pressing PUSH can send quite a bit of data. This may briefly interfere with the flow of a more intense sequence of MIDI events and cause a short pause. This is normal.

→ I. Global Settings and Utilities

This QB is where to access some other settings and Calibration utilities. Click and hold > 1 second to enter. Each menu item has a specific function described below. Most settings are Global which means they remain regardless of which PROGram is loaded.

ROOT EDGE: 0 Sets offset for Root CC if some root notes are too low or high. +/- 99 cents. If some notes are playing a semitone low, adjust upwards, if too high, adjust downwards.

ROOT CV ZERO NOTE:36 Root CV MIDI note @ 0 volts. Normally a multiple of 12, but if your system is "A" based, this would be offset by -3 (33). LHAND & ARP are based by this also. Does not affect Root Progressions as the are direct root notes.
**This setting is not Global so can be different for every PROGram.*

GATE DELAY: 2mS This sets the time CV's will be read after the rising edge of Gate input. Setting this higher may be required for slower sequencers that might have CV Slew. (i.e. BeatStep Pro) Slew could cause erroneous notes to be played as the CV was not at the proper level at Gate time. This setting is global.

NOTE OVERLAP? NO Turning this on will allow identical Notes on the same channel to be sent while the previous note is still on. Some synths don't like this. Melisma deals with this by quickly turning of the same note, then back on again.

SCREEN SAVER: YES This enables the Piano-roll screen saver. If turned off, the existing display will scroll across the screen but remain static.(unchanged) This is to protect OLED.

SEND SYSEX: NONE This is a One-shot selection to send Sysex Dumps. GLOBAL, THIS PROGram, or CV CHORDS lists can be sent. (See below for more)

LINK MERGE CHAN: ALL Allowed MIDI input Channel(s) to merge to MIDI out on panel (see [section V.](#))
LINK OUT CHAN:ALL MIDI Channel(s) that will send to MIDI LINK output (see [section V.](#))
LINK CTRL CHAN:16 MIDI Channel for Remote Control of Melisma via LINK input (see [section V.](#))
LINK OUT CLOCK:YES ACLK MIDI Clock allowed on LINK Output? (See [section V.](#))
CALIBRATE ZEROS Sets Zero Volt points on all 8 analog inputs (See next page)
CALIB ROOT CV GAIN Sets up Root CV jack. Accurate 4.0 Volt source required (See next page)
CALIB LHAND CV GAIN Sets up LHAND jack. Accurate 4.0 Volt source required (See next page)
CALIB CHORD CV GAIN Sets up Chord CV jack. Accurate 4.0 Volt source required (See next page)
LED BRIGHT:40 Sets LED brightness from 2 to 99. Does not affect OLED display

SETTINGS: SEND SYSEX

Melisma sends SysEx from MIDI out jack only. See the next section, J. below.

SETTINGS: CALIBRATE ZEROS

This menu entry will calibrate all CV analog jack's zero volt points. Make sure all of the jack are clear and that the module has warmed up to the point it would be during regular use (makes a slight difference) Once ready, click to select Calibrate Zeros and little hoops will appear as each jack is calibrated.

SETTINGS: CALIB ROOT CV GAIN

This menu entry will calibrate the Root CV gain factor. You will need an accurate 4.0V source. If you have a decent DMM volt meter and a stable source module, then that can be used with a mult off for the meter. Plug your 4.0 volts into the Root CV input, then click to select Calib Root CV Gain. The display will prompt to exit or proceed. This is for safety. Click the Arp button to do the calibration. If you get the message ****VOLTAGE ERROR**** then something is wrong with your 4.0 volts or the patch.

SETTINGS: CALIB LHAND CV GAIN / CHORD CV GAIN

These menu entries & procedures are identical to the Root calibration above, please refer to that.

→ J. SysEx for Backup

SETTINGS: SEND SYSEX

Found in **[SETTINGS]** QB, Click to select the type of SysEx dump you wish to start, then click again to send.

This utility is good for backing up the Melisma's Lists and settings, or transferring lists from one Melisma to another, directly or via .syx in an email. To record a SysEx file into a DAW or other permanent storage, you will need a program like MIDI-Ox or equivalent. In our examples here we'll assume you have MIDI-Ox.

In order to receive the SysEx back into Melisma, you will need a MIDI break-out module or patch from the Melisma's LINK header (see [Section V.](#)). If you don't have this, it's still good to do a back-up and if absolutely required a LINK patch could be thrown together with a pair of header jumpers and a hacked TRS plug cord.

There are 3 types of user SysEx sends:

GLOBAL	Does complete dump of all lists, settings. File size appx 21K
THIS PROG	Dumps only presently selected PROGRAM #, progression lists, and all of it's settings
CV CHORDS	Dumps all 8 CV Chord lists (not progression lists!)

In MIDI-Ox, make sure your MIDI input is selected by OPTIONS drop-down / MIDI Devices...

> In the MIDI Inputs box, click to highlight you MIDI input device. OK to exit.

> Now open VIEW drop-down and select SysEx... This will open the SysEx window.

> SysEx drop-down and select Configure...

Make sure the "Save Dump directly to a file" (at bottom) is checked.

> Select SysEx drop-down / Receive Manual Dump...

You will be prompted to enter a filename /location for the dump to save to. Use a name that includes the word "Global" or "Prog1" or "CVchords" so you know what they are in the future.

A small window titled "SysEx Receive" and the byte count will appear. You can now click on the Melisma's selected SysEx send to begin. The Byte count should change quickly then stop.

> Click Done in the little window.

You can now go and check out the .syx file saved. Use a regular text editor like Notepad in windows, or Text Editor (switch to plain text mode!) in Mac. It's very important note to use any "rich" text format as this will insert data that will not send properly when it comes time to send the .syx back.

If you just want to have a look any test editor will do, just don't save or it will be corrupted and unusable.

Editing the SysEx is beyond the scope of this manual. Please look in the Melisma support section on the site: <http://www.freshnelly.com/melisma/melisma.htm> for "SysEx Editing" document.

Now What?

The next page will cover how to get these SysEx files back into the Melisma.

LOADING A SYSEX

Via LINK input, a SysEx can be loaded at any time, even while the Melisma is happily playing your amazing new tunes! Some settings in MIDI-Ox *must* be followed though to ensure the interaction goes smoothly.

First unplug MIDI output from Melisma and connect it to the DAW's MIDI input. This is to stop feedback through MIDI-Ox.

In MIDI-Ox Options/MIDI Devices drop-down (on main window) Highlight your MIDI device in the MIDI Outputs Box and click OK

In the SysEx View and Scratch Pad window (that should still be open from the previous example) select the drop-down SysEx / Configure...

In the "Low level Output Buffers" section, change the parameter values as follows:

- > Size [1] bytes
- > Num [16]

In the "Output Timing" Section, set as follows:

- > make sure box *Auto-Adjust..* and *Delay..* boxes are unchecked
- > Delay Between Buffers [1] milliseconds
- ..and in the lowest section..
- > Make sure "Append To Bytes in Display window" is unchecked
- > Make sure "Fill Display Window as bytes come in" is also unchecked

Click OK to exit. Now you can either use the File drop-down "Send SysEx File.." to send your file or find it in your computer and double-click / drag it into MIDI-Ox.

? If you chose to use the double-click method the top window in SysEx View will be filled with the data. Right-click on it and choose send SysEx...

? If you used the File.. drop-down then the SysEx will just send once the file is loaded into MIDI-Ox.

Which SysEx Type Should I Use?

The type of SysEx you may want to store depends a lot on what you plan to do with it.

THIS PROG:

If you run out of space to store your PROGram progression lists then you may want to use this type of SysEx. When this SysEx is created, the leader in the file has the PROGram # so it will always load back to the same place.

If you want it to load into the presently selected PROGram#, edit the SysEx to "PROGRAM=0"

CV CHORDS:

Obviously editing the CV Chord Lists would be faster using a text editor rather than the Melisma's encoder!

GLOBAL:

This (for me anyway) would be a good way of saving a "performance" Melisma and loading an "experimental" Melisma. I'm a bit OCD about a performance that works well and try to duplicate everything that went into it, of course, so *that* variable is out of the performance equation. This could also be for when the Melisma is changed from one rack to another as different set of modules may be used differently with the Melisma.

If you have a second Melisma, this is a great way to clone one to another as well. Unfortunately, the Melisma does not send the SysEx's on the LINK bus so you'll need a MIDI break-out module/panel. This may change in a future Firmware update.

Please read the following Section to become familiar with the LINK header if you plan to use it ;)

V. Behind the Panel

Initially, while you may not be interested in patching in the backplane realm, and Select Bus requires no additional connections, it's worthwhile to have a look here at the great options supported.

→ A. LINK MIDI & Remote Control

The LINK I/O can be used with a MIDI breakout to merge MIDI with the Melisma to the Panel MIDI out, add remote control features, send SysEx backups back into the Melisma, or output a specific MIDI channel from the one of Melisma's play modes (i.e. LHAND, Arp, single MPE channel etc) for a different MIDI synth.

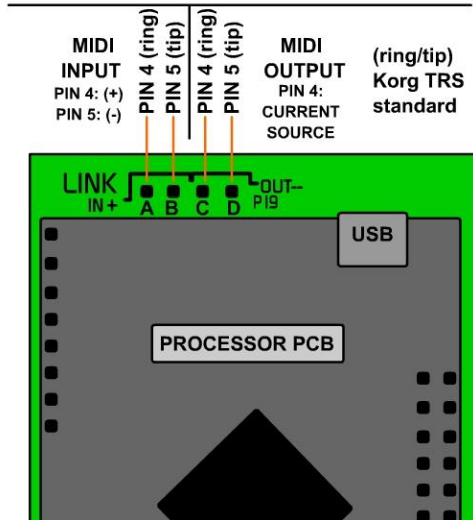

Behind the panel, the LINK bus can also be used to interface with other modules (i.e. ES Disting) and act as a MIDI break-out.

This pins are located at the very top of the module and are almost with the processor board to offer some protection.

Using simple female to female header jumpers (Tayda) will ensure any order can be achieved when interfacing with a MIDI breakout or other module.

These pins are quite robust, and the inputs are optically isolated, so don't worry about getting them wrong the first time.

The shown (tip/ring) configuration is for a simple header pin to TRS connector in the KORG standard. This is the more widely accepted format and is also the way the Melisma's panel TRS jack is wired.

LINK Usage

As already touched on above, there are many ways to use the LINK MIDI bus, the most obvious being adding a MIDI input to the Melisma. This gives the ability to mix extra MIDI signals if using a GM MIDI synth for either controlling certain parameters from a MIDI controller, playing along from a MIDI keyboard, or simply using remote control feature set of the Melisma.

LINK Configuration Settings:

LINK related settings can be found in the **[SETTINGS]** QB. Click & hold encoder to enter this menu.

Scroll down the LINK settings:

LINK MERGE CHANNEL:n	This sets the Channel(s) that will be passed to the panel jack. 1-16, or ALL
LINK OUT CHANNEL:n	This sets the Channel(s) that will be sent to LINK generated by Melisma
LINK CTRL CHANNEL:n	This sets the Channel <u>for remote controlling</u> (see below) the Melisma
LINK OUT CLOCK:YES/NO	A Stable ACLK pulse train will also send a MIDI clock to LINK output

Remote MIDI Root Offset Feature:

Once MIDI Remote has been enabled by selecting a channel, MIDI Notes/chords received on this channel will be used to offset the Root note in place of the ROOT offset control knob. The ROOT knob still has control over the octave though and changing it at any time will override the previously received MIDI setting.

Used with a Root CV- The CV will still offset the MIDI-modified root notes

Used with a Root Progression- The Progression will still offset the MIDI-modified root notes.

This feature has no settings so can be used as long as the input MIDI channel=LINK CTRL CHANNEL

- If chords are played, the Remote Root will find the lowest note and use that for the Root.
- If a higher note is down first then lowers, any Progression or Gate between those will use the higher note.
- Notes played between trigger times (Gate/Prog/LHAND/Arp) will not be played. Last notes are used.

Other LINK related settings...

Under [MIDI CC:x] you'll find the MIDI LINK Remote CC settings. Scroll to **--LINK CC REMOTES--**. Each LINK Input CC# for remote control can be set or disabled here.

PROGRAM # CC:n	This option assigns a MIDI CC or PC to switch Melisma's PROGram # Any CC# 0 to 127 will divide the CC value (0-127) by 16 to get PROG 1-8 If PC (program change) selected, then uses PC 1-8 (others are ignored)
CHORD LIST CC:n	This option will select a CV Chord list 0 to 7 or "ALL" from assigned CC value. This value is /15 so 9 selections can be made over CC range (0-127) The remote selection is not permanently saved to the PROGram preset.
LHAND SENSE CC:n	This option will enable adjustment of LHAND sensitivity (cents/millisecond) The CC value is translated to cover the full 10 to 300 cents range and is not permanently saved.
SPREAD MOD CC:n	This option selects a level of Spread Modification from 1-8 (divided over range) but will not change Quantization option yes/no. If Spread modifier ORDER, SWING, RANDOM is selected, this LINK remote will have an affect.
ARP TYPE CC:n	This option will select an Arp type (order) as does the Arp Button. The 8 states are divided over the CC value range (0-127) These Arp changes will not be saved permanently. The Arp LED & Display will indicate the Arp Type change.
ACLK TRIGGER CC:n	This option will mimic an ACLK pulse input on the rising edge. To be valid the CC value must exceed 63 and must be brought back low (<64) for the next. When HOLD is High, this is useful for tapping out notes in a chord.
HOLD SWITCH CC:n	This option will mimic a high state on the HOLD input as low:<64, high>63. When used with the above on a pad-style Hand controller, a new dimension is added!

Under [**PROG:n**] QB you'll find...

LISTS FROM LINK:YES/NO Will accept proprietary Root/Chord Progression and CV Chords lists data
from other SDS Digital Accord Series modules (i.e. Sequarallel)

Precautions to take when using LINK

LINK I/O

If using LINK with a breakout to and from a DAW, make sure the MIDI THRU setting in the DAW software doesn't allow received MIDI to be send back out again. This could cause a lock-up the moment a MIDI data is sent. This applies to hardware as well. Disabling LINK MERGE CHANNEL (above) in Melisma will prevent this also if you don't want LINK input MIDI sent to the Melisma's front panel. (i.e. for CC remote operations only)

LINK Out, Driving bus powered MIDI devices

As there is no ground pin on the LINK bus, if you plan to connect LINK outs to a MIDI breakout that might be used for low draw MIDI bus powered devices, a ground must be added at the breakout panel.

For a 5 pin type of MIDI jack, the center (pin 2) should be grounded to the rack PSU ground. (usually this is also the chassis ground) in order to get current.

For a TRS plug or jack from the LINK out, the (sleeve) should be grounded for current drive. If you have none of these in-line powered devices then you can omit this step of course. MIDI doesn't need it.

Passing a SYSEX

Any SysEx (System Exclusive) received at LINK input will not be passed to the output on Melisma's panel, it will be ignored unless is a 0x7D ME ...

a) followed by PROGRAM=n and data to load present program with settings and progression lists

b) followed by GLOBAL and data to load entire backed up setting and lists

c) followed by CHORDLIST=n and data to load to CV Chord lists

See [Section IV. J. SysEx for Backup](#) for more on using SysEx on LINK

SysEx Send on LINK

SysEx Dumps are not sent on LINK, the front panel MIDI out must be used. This may change as a firmware update once more LINK compatible modules come out (i.e. Sequarallel) so this has been done as a precaution.

MIDI CLOCK

If a MIDI Clock is present on the LINK input, and you wish to have it present on the panel MIDI out jack, there is an option to disable ACLK clock generation under the [ARP INSTR:n] QB. Click and hold to enter it and select ACLK→MIDI:YES to "NO". This will only apply to the present PROGram#, not globally.

→ B. SELECT BUS

Select Bus is a "New-ish" format of data interchange that uses the second last pair of pins (the old CV bus) on the PSU header/ribbon. This is to change states or presets on other Select Bus enabled modules (i.e. ES Disting MK4, Rene) by sending a Preset/State# 1 to 64.

Most modules on this bus are Slaves, but some are Masters or both.. The Melisma can be master or slave, and has an Automatic mode that will stop being a master if another master is received. Once in this slave state, the user must manually hit the SELECT BUS QB to regain "mastership".

Melisma as a SB Master:

Select bus messages are sent by a PROGRAM change (1-8), and optionally when HOLD input logic goes from low to high, and high to low. This is useful for changing audio filters/FX on an arp.

The SB Preset/State# can be set to any from 1-64 for each PROGRAM. Using the SELECT BUS QB to select a Preset# to send will permanently assign the number to the present PROGRAM.

Entering the SELECT BUS menu:

This QB is Slightly Different from the others. Scroll to the QB and press and hold for 1 second to enter the menu. Do not have the SELECT BUS:## highlighted then hold. This will send a Preset/State Store message to all modules which will update them to the present Preset/State#!

Once behind the SELECT BUS QB, messages to send when the HOLD input changes are located:

SEL-BUS HOLD HI: --- This sets the SB preset# when HOLD is pulled high for arp'ing
SEL-BUS HOLD LO: --- This sets the SB preset# when HOLD is return low
CC SEL-BUS: 1-8 This is to set range of States/Presets selected by CC CV if CC CV is enabled to do so
PROG→SELBUS: YES This can turn off this PROGRAM sending a select bus preset # when loaded

Scrolling down...

-----GLOBAL-----

ON SEL-BUS AS: MASTER Selects Melisma's role on the Select Bus Master, Slave, or Auto
MELISMA SYNC: N/A This is to sync roots/chords with another Melisma over Select Bus (See below)

As a master, the CC Select bus function, when chosen for the CC CV input, will always send Preset/State# according to the range setting above. These ranges are 1-4, 1-8, 1-16, 1-32, and 1-64.

Care must be taken when using this function. A quickly changing CV will inundate the bus with data and some modules on the SB might not respond well. Best use a CV sequence that changes less, or a lower Preset range (1-4 or 1-8) so there's less messages sent.

Melisma as a SB Slave:

Selecting Melisma as a Slave means that no Select Bus messages will be sent. This ensures uninterrupted use of another module as a master (i.e. Storage Strip module)

Behind the SELECT BUS QB, scroll down below --GLOBAL-- to **ON SEL-BUS AS:???**, click it and select **SLAVE**. Near the top of the menu list, click on SELBUS SLAVE:nn and choose your Preset/State number for this PROGRAM. Any time the Master sends *this* number, the Melisma will load *this* PROGRAM.

Melisma in SB Auto Mode:

The Melisma can be passive on the bus automatically when set to AUTO. If any Preset/State# (1-64) matches one that has been assigned to one of Melisma's 8 PROGRAMs, the PROGRAM will change to that one. Once a SB message has been validated, the Melisma will remain in Slave mode until the user forces a Master send by Selecting the SELECT BUS QB. Just selecting it, then deselecting will execute and turn Melisma into a Master.

Once in AUTO but as Master, the HOLD hi/low messages will be sent along with CC CV (see above) if it is assigned the SEL BUS control function, and of course the PROGRAM change message.

No Select Bus:

If your system uses the PSU Select bus for a CV line then it's best to either use an isolation PSU ribbon to cordon off the Select Bus modules (or the CV modules), or disable the Select Bus features on connected modules (for safety and order)... or if you just don't want to use Select Bus it can be disabled. Under the SELECT BUS QB, scroll to **ON SEL-BUS AS:???**, click on it and select "N/A".

Melisma Sync:

If you are lucky enough to have two Accord Melisma modules, they can communicate a couple of very useful data's: Chord and Root. When enabled (under the SELECT BUS QB scroll to **MELISMA SYNC:???** and change to ROOT, CHORD, or BOTH) the master Melisma will send it's Root and/or Chord to the slave Melisma. If the slave's Root or Chord jack is clear, the Root and/or Chord will be duplicated. This can be very useful for combining two very different timbres without losing the key and worrying about matching CV's, or for creating compound chords of up to 14 notes, dual Arp's etc. on different synths...

Preset/State Store:

If the Melisma is acting as a master or AUTO, it can send a Store message to other modules. This will make their present state or preset accessible under the present SB number. To execute this function:

- 1-Scroll to the SELECT BUS QB.
- 2-Click on it to select the Preset/State#.
- 3-Turn the encoder to select the desired preset/state number
- 4-Press and hold the encoder for 1 second. The message will be sent and QB exited.

Store Message w/ Melisma as Slave

If the Melisma is a Slave (or in AUTO) the a Store message received by a master module (such as the Storage Strip) will register that selected state to the PROGRAM# Melisma is presently using. This does not affect the Master select bus State/Preset#. The Store commands number will be visible in the [**SELECTBUS:n**] QB.

Storing the HOLD messages:

Once the **SEL-BUS HOLD HI** and **SEL-BUS HOLD LO** Preset/State#'s have been set (usually **HOLD LO** will return to the same PROGRAM Preset/State#, but doesn't have to!) the receiving modules must be configured to understand which Preset/State they will switch to when the messages are received. Most modules don't have this facility but it can be easily done from the Melisma side. Assuming the HOLD HI/LO select bus #'s have been set:

- 1-Setup the slave module(s) to the state you want to load when Melisma's HOLD is high.
- 2-On the Melisma, scroll to the SELECT BUS QB.
- 3-Click on it to select the Preset/State#.
- 4-Turn the encoder to select the number that you set **SEL-BUS HOLD HI** to.
- 5-Press and hold the encoder for 1 second. The message will be sent.
 - if the **SEL-BUS HOLD LO** is the same as the PROGRAM Preset/State# -
 - 6-Click on the SELECT BUS QB to dial back to the original # used by PROGRAM.
 - 7-Click again to exit the QB. The Slave module(s) will return to their previous state.
 - if the **SEL-BUS HOLD LO** is different from the PROGRAM Preset/State# -
 - 6-Change the Slave module(s) state you will want to load when HOLD returns low
 - 7-Click on the SELECT BUS QB to dial to the number you set HOLD Low with.

*Note that some modules use Select Bus Preset/State# 1 as a "last modified" state. This will change every time you Store a new state on that module. It's best to avoid Preset/State# 1 unless that's what you want. (The Melisma factory reset will set PROGRAM 1 to this value so be warned!)

Conclusions:

While Select Bus can be a real PITA to set up, it has great benefits. With the Melisma these changes won't directly select stuff for the output (unless SB is controlling an audio mixer/filter with your MIDI synth patched through it), but can change stuff that is controlling the Melisma. For example switching percussions on a Disting MK4 with HOLD transitions, or selecting samples via CC CV Select Bus range.

While the Melisma can load PROGRAMs fairly quickly, there is always an "all notes off" sent and many settings may be changed or PUSHed when the change occurs so it's rarely a smooth transition. Try to refrain from doing fast (multiple per second) Select Bus changes either way. Some modules will hang or disengage and don't like it at all!

VI. Theory of Operation

This section puts it all together in a (hopefully) prompt and concise way that is informative as well as interesting. Please keep in mind this guide is preliminary and the final user manual won't be written by me (yay!) so if you can't deal with my writing methods (you're not the first!) used here, just wait a while.

MIDI Creation!

Def. "Roots": The lowest (no inversion) note in a chord, the chord's key.

Def. "Chords": Fixed intervals of notes above the Root spanning 1 or 2 octaves between 3 and 7 notes total

The Melisma has 4 main ways of creating MIDI output:

- 1-Gate+(Root CV and/or Chord CV) inputs to select and play chords in different keys
- 2-Root Progression and/or Chord Progression triggers to step through lists of roots/chords and play them
- 3-HOLD+ACLK to play Bursts of chord notes or Arpeggio.
- 4-LHAND (Left-hand) to play bass, melodic, scale quantized notes, or percussion

For all methods, logic level high on the GATE input will set the duration of notes from a few milliseconds to several seconds. Roots and Chords selected via CV will play at Gate on time.

(1) Gate+(Root CV and/or Chord CV)

The Root control (knob) can select +/- 24 notes from Zero Volt Note (settable in Settings QB) so the Root input is bi-polar +/-5V @1V/Octave. You'll likely use the positive side mostly so an ideal Zero Volt Note is 36 (+/-24) for "C based" systems.

The Chord control acts as an attenuator but with set number of Chords. If your User Chord List has 12 chords, then setting the knob fully CW would allow CV access to all 12 chords. The top display will show 12 when the knob is moved. Turning the attenuator to 50% would allow CV access of only 6.

Because the User Chord List has low/high limits, turning the knob fully CCW might show 4 while fully CW still at 12. This now gives CV access to only 9 chords, Chord 4 to 12.

(2) Root Progression and/or Chord Progression triggers

The second method of making MIDI chords is to use Root/Chord progressions.

Sending a trigger to Root or Chord jack will switch it to Progression mode and step through the Root's or Chords in the progression lists. Each trigger will also play a chord with note duration determined by the last known Gate.

The progression lists can be 1 to 32 steps each and are loaded with the PROGram#.

These lists, accessible for editing under the top two QB's, can be used along with the CV method on either Root or Chord (i.e. Root Progression with CV Chord). The CV selection will be loaded along with the progression selection to play the chord at the trigger.

The Chord knob is muted during a Chord progression, while the Root knob during a Root Progression still acts as a +/- 24 note offset. This accommodates transposing a Root Sequence.

(3) HOLD+ACLK

The third method of creating MIDI is by switching Chords to Arpeggios (or bursts of notes) triggered by the ACLK input by applying a high state to the HOLD input. Thusly named because the notes are "held" until ACLK triggers them in sequence. If notes from a chord are still playing at this time they won't be interrupted by this change giving notes a fluid flow from one to the other and back.

The order the notes are played is determined by the Arp Type button (1 of 8 types) under the encoder.

A GATE input will update the Root/Chord CV selections and apply them seamlessly to a running Arp as will Root or Chord List Progressions. Progression triggers will not play chords while HOLD is engaged.

Arp notes can have their own MIDI channel, thus instrument, and offset making the format useful in all applications.

(4) LHAND

LHAND, AKA Left-hand, is semi-independent from the rest but still relies on the GATE input's high state to determine the lengths of notes, (even though there is a way to change these individually using a CC CV function) and in some cases ACLK to get timing info.

The LHAND CV/Trigger input is classed into 4 types of operation:

- a) Bass Notes. A logic level gate alone will always play bass notes that follow music rules to the chord.
- b) Scaled Notes. A changing CV input (1V/Octave) will follow the Chord as a scale quantization regardless of octave. The amount of change (**LHAND SENS:n** Cents/millisecond) can be set under LHAND INSTR:n QB. Average is 80 C/mS (0.07V) Setting **NLOCK** (Note Lock) to "Y" will choose this type of quantization.
- c) Melodic Notes. A changing CV input (1V/Octave) will follow the melodic 2nd note only but still uses the amount of change setting above so can play the same note at any time. **NLOCK=M** is melodic.
- d) Percussa. This mode (Set under any of the upper 4 LHAND QB's) is very different from the rest but still uses the amount of change setting above. When there's a registered change percussion notes are accumulated, then at a rising edge on ACLK are played all at once. This gives up to 8 drums polyphony.

Even though CV LHAND can create notes on it's own with just "rate of change", CV LHAND Types b, c, and d will use a time base to sample the CV if available and near to the time of the change.

This timing is readily selected in the LHAND:T=xxx QB:

ACLK1, ACLK2, ACLK4: ACLK input Trigger to Trigger time, 1/1, 1/2, and 1/4 time

GATE1, GATE2, GATE4: Gate pulse duration time /1, /2, /4 duration

20mS to 250mS Fixed: Fixed interval set by clicking on it once highlighted.

The sample time tries to quantize to ACLK or Gate when near so odd timings are possible.

Using the Gate for a time base is good for playing triplet runs by simply adjusting the Gate length.

LHAND Percussa In-Depth

Percussa mode is a new way to make some quirky rhythms to go along with the notes playing. These can resemble an "all out" heavy drum solo, or just a passive rhythm. Knowing how to use it will augment your experience with the Melisma.

Percussa is basically an 8 note (drum) accumulator that adds drums into a buffer, then plays them all out at once as ACLK goes to high state. This gives Percussa polyphony.

As with LHAND there are rules to stop fast moving CV levels from piling up notes immediately:

1) Sample Rate

Percussa samples at a rate set by the [**LHAND_T=**] QB parameter. ACLK1 will only accumulate 1 or 2 drums, while ACLK4 will get 4 or 5. This is obvious as ACLK is also the play trigger!

GATE1 to 4 could be any amount depending on the duration of the Gate.

Fixed user time (20mS to 250mS) shorter settings can fill all 8 in a very short time.

- 2) Cents/millisecond setting. If the CV is a complex signal (like a sequencer or random) higher settings won't produce new notes if the rate of change falls short. So settings above 100 C/mS will miss single semi-tone changes, or subtle LFO deviations. 100 Cents = .083V so a setting of 10 is very sensitive! As with LHAND, setting just below 100 will follow a CV sequence predictably.

Percussa is far from a random generator of notes though. If LHAND is patched to a sequencer, each cycle will play the same drums the same way -if sync'ed with ACLK. If not synchronized, Percussa gets interesting as the same drums are used, but run in and out of phase which mimics perfectly drumming methods.

Try patching a Sequencer on a different clock over to LHAND, then change the sequencer's clock rate. Notice how the rhythm, although at the same tempo, becomes busier? This is the perfect tool for builds and is easily controllable. Try changing LHAND ZVN=24 to 25 to select a different set of drums.

Try changing Percussa channel to non-percussion channel (i.e. 12 or same as LHAND) to hear notes.

Chords can be played this way, with as many as 8 notes. Reducing the sequencer's clock rate will "thin out" the chords. ACLK's pulse width will set the length of notes. Remember that the only offset is [ZVN=n] and doesn't track with Chords.

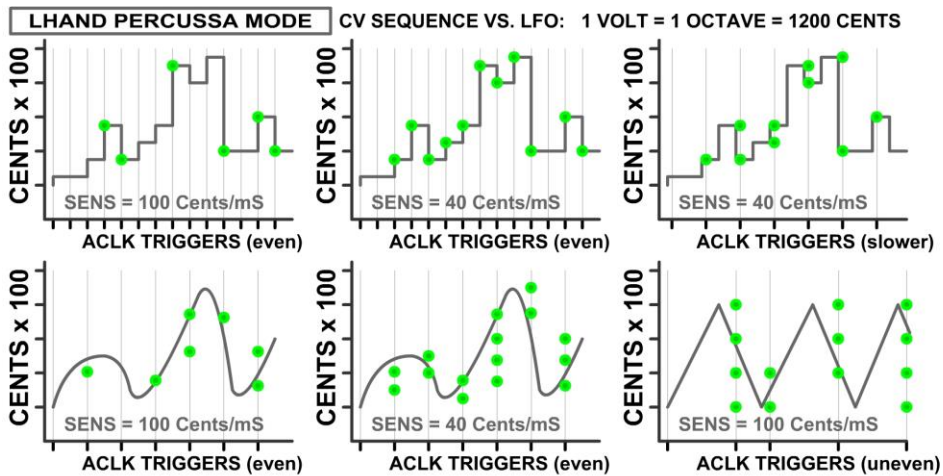

The above image attempts to visually explain Percussa with examples of different Sensitivity levels. The green dots vertically represent number of drums played in a basic way. The ACLK triggers assume LHAND_T=ACLK1.

As ACLK is the play resolution that your drums will have, picture them as 1/8 or 1/16th's in a reasonably paced environment. ACLK can be non-clock triggers too as shown in the last diagram.

TIP: CC CV input has a function "HANDT" that controls Fixed time 20-250mS so can be used to CV control the density of LHAND notes and, yes, Percussa! (LHAND_T=?mS must be selected.)

Manipulating Chords

There are several ways, apart from selecting Chords and Roots, to change the way a Chord plays.

Manipulating Chords: Spread:

The Spread control and CV sets the amount of time space between each note. This space is set at the moment the Gate triggers the Chord to play. Each note the follows will play at exactly this time. While this seems rather rigid, the human ear barely distinguishes mild changes in timing, especially if the notes are close together, so having an extra control to manage for specifically that purpose is nearly redundant.

That said, there *are* Spread options to add Swing, change the order notes are played, or add an element of randomness to the timing:

RANDOM_T Adds/subtracts time (relative to Spread setting) randomly up to 50%
SWING Adds true swing from point of Gate to all notes 1-late-early-late etc. Near 100% at 8.
ORDER Changes the order of notes depending on the Chord length (see below)

This setting is under the [**Spread Q=n**] QB as SPREAD MODIFY:x

Once one of these modifiers is selected, scrolling through the [**Spread Q=n**] QB will display N,1-8,Y.

The numbers 1-8 is the intensity setting for the modifier. i.e. Swing at 8 is maximum swing.

The Spread quantizing can still be turned off/on by scrolling to "N" or "Y" first, then choosing a number.

Leaving the QB at "Y" on "N" will assume intensity of 0.

Chord Note Orders:

Selecting 1-8 when Spread Modifier is set to ORDER will change the order of notes played according to the size of the Chord. I won't list all of the variations as this would require a page or two ;) but they try to follow the theme shown here. This is for the 5 note chord...

x: 0, 1, 2, 3, 4	Original order (just "Y" or "N" selected)
1: 0, 4, 3, 2, 1	Reverse
2: 0, 2, 1, 4, 3	Interleaved
3: 0, 1, 4, 3, 2	Half reverse
4: 0, 4, 1, 3, 2	Inward
5: 0, 2, 4, 1, 3	Every Second
6: 0, 3, 1, 4, 2	Triple Spread
7: 0, 3, 2, 4, 1,	Outward
8: 0, 1, 3, 4, 2	Paired

For shorter chords some of these are duplicated as there's only so many combinations.

The Root note is always the original, but Inversion is applied beforehand so the variation becomes almost unrecognizable but still works with the original chord. Played quickly they take on a rhythm as well.

CC CV Control of Spread Modifier:

The CC input jack's function can be set to select the intensity of the Spread Modifier from 1-8 by changing [**MIDI CC:x**] QB to "SPR_M". The 5V range is 1 of 8 and the knob acts as an attenuator as usual.

MIDI LINK Remote Control of the Spread Modifier:

Under the same QB scroll to "--LINK CC REMOTES--" and find "SPREAD MODI CC:n" to assign a CC# on the remote control Channel if you want to connect a MIDI controller to the LINK input.

Manipulating Chords: Inversion:

Inversion is simply shifting the notes in a Chord up +1, +2, etc. to change the first note played while adhering to the scale the chord creates. i.e. CEG with first inversion would be EGC, then GCE.

As Melisma adheres to the classical rules of music, (unlike some DAW software's) the maximum number of inversions on any Chord is number of notes in the Chord - 1. So a 3-note Chord can only have 2 inversions.

Controlling Inversions on different sized Chords:

So the Inversion knob (no CV) is all the way over and there's 3 note chords playing. Then a 7 note chord plays but on it's 2nd inversion. If the knob is adjusted at all it will jump to it's 6th inversion.

If the inversion on the 7 note chord is set to +5, and a 3 note Chord follows, the 3 note chord will use +2.

If the inversion control knob is unchanged and a 7 note chord is played, then it will resume it's +5 inversion.

Had the knob been changed at all during the 3 note Chord, the 7 note chord would use the 3 note inversion limit.(0, +1, or +2)

-With a CV

This presented a conundrum when a CV is applied so the Inversion CV (with knob fully CW) is quantized to the Chord at 1V/Octave. If the CV voltage is greater than the next note in the Chord (with Root note regarded as 0 volts) then the inversion to that note will happen.

Musically this is a logical way to control Inversions, but is completely thrown out the window as soon as the Attenuator (0-100%) is lowered. Still, this method seems to work well regardless!

Manipulating Chords: Expand:

Expand has already been covered fairly well on Page 5 but I'll add a bit here.

This input should be regarded as exponential in nature and results will vary wildly with the size of Chords, and their present pitch. As mentioned earlier, Expand spreads the chord (pitch-wise) over the range by rules of skipping notes in the chord to the next without repeating the Root note. Musically this is intrinsic to avoid the Chord sounding like another entirely.

Relatively small changes in CV with a small Chord will span the entire range very easily because there are less notes to expand into. Larger Chords will react less as there are more notes to fill. The CV range with smaller Chords will seem less segmented (i.e. triad from note 36 is max after only 8 expansions) whereas a larger Chord will be very segmented (i.e. 7 notes Chord from Note 36 is max after 11 expansions).

Most of the Expansions you'll be doing will probably be in the lower range up to 2 volts but jumping beyond that will add "Sparkle" to some instruments.

Manipulating Chords: Velocity:

As Velocity is a real-time note modifier, it can be used with a Gate sequencer to remove certain notes interestingly. This works best when there is some Spread involved but if you have a fast burst/clock source notes can be removed from almost simultaneous Chords. This method adds a new way to play Chords.

While patched, the Velocity control to the left acts as a limiter and CV has absolute control over the levels. If turned to right of center, the CV will be added to the knob's value as mentioned earlier.

TIP: Applying a 50/50 square wave to the Velocity CV that is half of the Chord's trigger rate will produce an Echo effect when the Velocity control it right of center.

Manipulating Chords: Pitch Bend:

The Melisma has an odd feature when CC CV function is set to P_BEND and the Bend Range is set to +/-12 semitones (Settable under [CC MIDI:x] QB). A 1V/Octave feature can be enabled (also under the QB) which lets any 1V/Oct sequencer create "mini-Arps" within each note! Used with IMPRINT CC CV mode it is pure magic. With MPE even more so. Check out the next section for more.

CC CV Functions

As we have already gone over all of the CC Functions on Page 13 & 14, I will only highlight the more discrete functions and their many uses here.

CC Function: Pitch Bending

As just mentioned on the previous page, CC CV can be used to Pitch bend in a predictable way at 1V/Oct which is convenient for easy setup. The remaining voltage 2 to 5 volts simply wraps around so can be used with those voltages also. When the CC Function is pitch bend, the input responds to bipolar CV so it'll go either way giving a total of 24 notes of pitch control.

This mode is not quantized so there's the possibility of slewed Portamento's in your mini-sequencing as well. So to re-iterate on accessing this feature:

- Click and hold on [MIDI CC:x] QB to get into CC settings
- Select CC FUNC: and scroll to PITCH BEND (is quicker to do here) and click
- Select CC SAMPLE & HOLD: YES and set to "NO" if not already.
- Select BEND 1V/OCT: Y to set to "Yes" (should be by default) and click
- Select BEND RANGE: 2 and set to 12, then click (this only works with +/-12 semitones)
- Exit the menu (hold encoder down >1 second)

Remember to turn the CC control all the way up as it is an Attenuator with Pitch Bend Function.

* Note that (hopefully) your synth has the capability of +/- 12 semitone Pitch Bend or this won't work...

If you are going to use MPE it should be turned on first, or use PUSH to update the synth.

If you are using Gate to play Chords, then you may turn on IMPRINT to capture the CC CV's and apply those envelopes to the Pitch Bend on a per-note basis.

CC Functions: PC (Program Change):

Using a CV to control instrument selection seems rather suicidal doesn't it? Because most Synths require a moment to switch instruments, the Melisma has a 100 millisecond block after a PC has been made. This will still change instruments at 10/second which seems slow but when you consider MPE mode with a non-compliant GM Synth will need 7 channels of instrument changes, it's going to be a bit demanding on some hardware, and probably very demanding on DAW synths. (That has not been tested yet!) Changing instruments quickly is a bit crazy anyway right? ... or is it... (sinister suspenseful stab to fade)

CC Functions: ARP GATE:

As the Arp/Burst mode (HOLD input set high) note's lengths are based on the last GATE length, this CC function gives some freedom in the way these notes play. With the CC knob fully CW the CV can set a range of 1% to 200% of the GATE length. As the CV gets close to zero volts, the lengths become very small and once zero volts will effectively pause the Arp stepping. This has an advantage over releasing the HOLD input as it doesn't reset the Arp step. A simple divided gate input can add pauses selectively.

CC Functions: PROG RESET:

Using the CC CV as a Progression Reset input seems like a waste of an input (and it is if you're not using the ACLK input for anything) but it's totally unattached. It can also be used in tandem with any of the other resets even though CC CV is not selected in the PROG RESET: option. Because the logic inputs (HOLD, ACLK, GATE) are edge triggered at 0.6 volts, while the CC CV could be set to 2.5 volts, this may be useful in some apps. A dual reset from a ramping CV could work. The first reset happens right after zero, while the next somewhere mid-stream, or higher. (remember the CC Knob sets the trigger level up to 4.9 volts).

CC Functions: With IMPRINT Mode:

To re-cap, when IMPRINT CC CV Mode is turned on, the CV input is sampled at the CC CV rate and recorded into a rig buffer while the GATE input is high. The maximum duration per GATE can be 10 seconds before it overwrites itself. This recorded CV is played when there is a note to trigger it so each note played can have the same CC envelope.

Because the source (i.e. Chords, Arp, LHAND, Progressions) of the IMPRINT triggers can be turned on/off, different parts can use the envelope while others not.

If used with MPE mode (each note has it's own channel), a regular GM MIDI synth can sound like an analog synth (i.e. using CC#74 and PUSHing CC#71 to a high value) and a true MPE poly-synth can use the envelope for all sorts of parameters that are beyond the immediate capabilities.

* Note that IMPRINT has no affect on *internal* CC CV controls such as Progression start/ends or Arp Gate. IMPRINT isn't channel dependent as the triggers as, but CC Channel should be on a relevant channel for when it's not in use. - IMPRINT overrides CC Sample & Hold.

CC Functions: With Sample & Hold

When CC Sample & Hold is turned on, (IMPRINT must be off) when any note (Chord, Arp, LHAND) plays, the CC Function and value will be sent just before. This can be useful for sending a static "snapshot" to make each note different according to CC CV's assigned function and parameter. The most obvious use is to control panning, pedal, or "brightness" (rez/cut in many synths) but micro-tuning via Pitch Bend comes to mind...

- * Note that the CC Channel must be the same as the Channel with the Notes, i.e.
 - Chords Channel for Chord notes, or Channel 1 (Zone Master) if MPE mode is on
 - Arp Channel for Arp Notes
 - LHAND Channel for LHAND notes

Progressions

Root and Chord Progressions and their lists are one of the more powerful features of the Melisma. One list can be used several times by simply changing the start/end points, or involve a longer sequence with Root and Chord progressions mult'ed together. Realistically a progression sequence could predictably use all 32 steps.

One progression can be used without the other (it could be under CV control) giving endless combination and timing possibilities.

Using two different trigger sources for stepping involves perhaps a bit of planning if there's to be an intentional outcome, but can yield some interesting results as everyone knows. Adding the "Pause" flags can turn a very simple pair of progressions into something much larger and more complex.

Pause

Pause requires that (a) both Root and CV are presently progressions (triggered) and (b) that both have at least one pause in the progression. The former is detected and if false will not pause. The latter is not detected and, depending on the "window" that the other progression is in, pauses may or may not be there. This was intentional as CC CV can control Low/High limits and windowing of that range, a range that may suddenly include a pause.

As mentioned earlier, when a pause is encountered, that step is played but will then wait until the other progression also hits a pause at which point they will continue together. In this diagram (I'll keep it super simple!) Each progression has 4 steps and both are being stepped together. The first pause arrangement will cause every chord to play before the next chord plays. The second causes Roots with pauses to wait 3 progressions and the third to cut the first pause short and offset to one before.

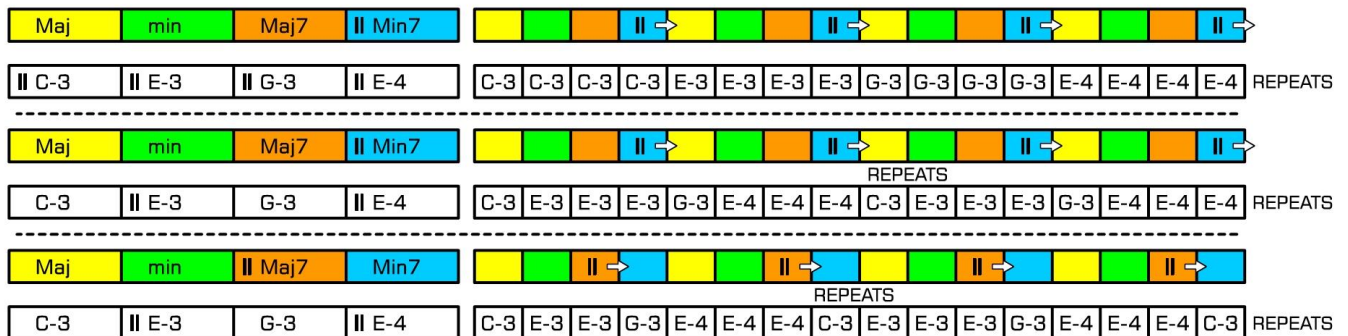

VII. Chord List & Info

Here is the Chord List in all of it's entirety. The example Chord is based on the key of C.

00:	Maj	C E G	32:	min7♭9	C E♭ G B♭ D♭
01:	min	C E♭ G	33:	minMaj7♭9	C E♭ G B D♭
02:	Maj#5	C E G#	34:	Maj7#5♭9	C E #G B D♭
03:	M♭5	C E G♭	35:	7#5♭9	C E #G B♭ D♭
04:	dim	C E♭ G♭	36:	min♭9♭5	C E♭ G♭ B♭ D♭
05:	sus2	C D G	37:	dim♭9	C E♭ G♭ B♭ ♭D
06:	sus4	C F G	38:	7♭5♭9	C E G♭ B♭ D♭
07:	sus2,4	C D F G	39:	7,6	C E G A B♭
08:	add9	C E G D	40:	7sus2,4	C D F G B♭
09:	min add9	C E♭ G D	41:	7#11	C E G B♭ F#
10:	Maj6	C E G A	42:	Maj7#11	C E G B F#
11:	min6	C E♭ G A	43:	Maj7#11	C E♭ G B♭ F#
12:	Maj#11	C E G F#	44:	7sus4♭13	C F G ♭A♭
13:	7	C E G B♭	45:	Maj9	C E G B D
14:	Maj7	C	46:	9	C E G B♭ D
15:	min7	C E♭ G B♭	47:	minMaj9	C E♭ G B D
16:	minMaj7	C E♭ G B	48:	min9	C E♭ G B♭ D
17:	Maj7#5	C E♭ G♭ B♭	49:	Maj9#5	C E G# B D
18:	7#5	C E G# B♭	50:	Maj7#5#9	C E G# B D#
19:	min7♭5	C E♭ G♭ B♭	51:	9#5	C E G# B♭ D
20:	dim7	C E♭ G♭ B♭♭	52:	Min9♭5	C E♭ G♭ B♭ D
21:	7♭5	C E G♭ B♭	53:	dim9	C E♭ G♭ B♭ ♭D
22:	Maj7sus2	C D G B	54:	7#5#9	C E G# B♭ D#
23:	7sus2	C D G B♭	55:	Maj11	C E G B D F
24:	Maj7sus4	C F G B	56:	min11	C E♭ G B♭ D F
25:	7sus4	C F G B♭	57:	minMaj11	C E♭ G B D F
26:	Maj7sus2,4	C D F G B	58:	11	C E♭ G♭ B♭ D♭ F
27:	7#9	C E G B♭ D#	59:	Maj7#9#11	C E G B D# F#
28:	Maj7#9	C E G B D#	60:	Maj13	C E G B D F A
29:	min7#9	C E♭ G B♭ D#	61:	min13	C E♭ G B♭ D F A
30:	7♭9	C E G B D♭	62:	13	C E G B♭ D F A
31:	Maj7♭9	C E G B D♭	63:	minMaj13	C E♭ G B D F A

Important Information. . .

Considerations when using CC CV with MPE:

When MPE is active, IMPRINT is off, and CC CV is being CV'ed by a constantly changing CV while sending on up to 10 channels at once, many MIDI messages will be produced with densities approaching 1000 messages per second.

While the Melisma has no problems with this and the MIDI standards require the capability of MIDI hardware to handle this much throughput, keep it in mind if MIDI merging either through the Melisma or after Melisma into a single stream. Precisely. MIDI is capable of 1041 MIDI messages per second. If the CC CV is full out as described above, this leaves 41 messages left for MIDI notes.

Probably the worst LFO signal would be a multi-Hz triangle waveform as there's no peak or trough resting period. Audio rate signals is another (which has been tested)

The Melisma has large buffers for merging but with those buffers might come a slight bit of latency if getting overloaded with data, please keep that in mind when merging. The only true test is to try it out. Our tests confirm that the buffers are enough to carry most situations, well, any tested.

FACTORY RESET

If you have monkeyed up all of the settings or just want a nice fresh module (like the day it was new!) you can do a factory reset. This does not affect the Calibration Settings.

There are two ways to do a factory reset:

Still in the rack- Hold Encoder and Arp Button down while powering up the rack.

Out of the rack- Hold Encoder and Arp Button down and tap the Red reset button on the processor board.

The screen will stay blank for a few seconds, then voila! Fresh & New!

Maximums & Minimums

Maximum Note Length: 30 seconds

Maximum Chord Polyphony: 40 Notes

Maximum Arp Polyphony: 32 Notes

Maximum Percussa Accum: 8 Notes

Maximum Imprint Envelope: 10 seconds

Minimum CV trigger (recommended min.): 2 mS

Min CV trigV: 4.2V

Minimum Logic trigger (recommended min.): 1 mS

Min Logic V: 0.6 V

SDS 24/01/2020*