

SDS ACCORD SEQUARALLEL

Owners Manual

v. 1.6

I.	Introduction	pg.05
A.	The Panel & Backplane	pg.07
B.	Quick-Box On-Screen Buttons Guide	pg.08
C.	Song Projects + Song:00	pg.08
II.	The Sequencers	pg.09
A.	MIDI Song Sequencer / Looper	pg.09
1.	Recording a MIDI Song For Looping	pg.09
a.	MIDI Setup + Planning	
b.	Clocking	
2.	Setting Loop Button Actions	pg.10
a.	Change what Loop Button displays	
b.	Set what will Loop	
3.	Adding Song Loop Markers [LOOP:NO]	pg.10
4.	Applying Song Loop FX	pg.11
a.	Song FX Settings	
b.	Swing (Global)	
c.	Scales + Settings	
d.	Limit (Notes)	
e.	Quantization	
f.	Length (Notes)	
g.	Levels (Velocity)	
h.	Mirror (Notes) + Settings	
5.	The Song Loop FX SEQ Mask Sub-Sequencer	pg.12
a.	Settings + FX	
b.	Move (Mask)	
6.	Applying Song Loop FX to Layer & TRAX Sequencers	pg.13
a.	Transpose	
b.	Scales	
c.	Use Song Fx (Layer Sequencer)	
d.	Use Notes Re-trigger	
B.	MIDI Layer Sequencers	pg.14
1.	Recording MIDI Layers	pg.14
a.	Bars Setting	
b.	Record Options	
c.	Append Option	
d.	Removing a Layer	
2.	Applying Layer FX (QB Button Global)	pg.14
a.	Levels (Velocity)	
b.	Quantization	
c.	Mirror (Notes) + Settings	
d.	Scales + Settings	
e.	Limit (Notes)	
f.	Transpose	
3.	The Layer Sequencer Editor	pg.15
a.	Including / Omitting Layers	
b.	Adjusting Step Sizes	
c.	Applying Layer Sequencer Step FX	

II. Sequencers Cont...

- C. TRAX Tracker Sequencers [pg.16](#)
 - 1. Using the TRAX Tracker Editor [pg.16](#)
 - a. Tracker Settings (Setup) [pg.16](#)
 - b. Adding Notes and Editing Methods [pg.17](#)
 - c. Note FX Bundles [pg.18](#)
 - 2. Recording to a TRAX Sequence [pg.19](#)
 - a. Record Settings
 - b. Direct Recording/Overdubbing
 - c. Legacy Sequencer Control Method
 - 3. Applying TRAX FX (QB Button Global Drop-Down) [pg.20](#)
 - a. Levels (Velocity)
 - b. TRAX Swing + Swing Mask
 - c. Mirror (Notes)
 - d. Scales + Settings
 - e. Limit (Notes)
 - f. Transpose
- D. Automation Recorder [pg.21](#)
 - 1. Recording an Automation [pg.21](#)
 - a. To Send MIDI CC/AT/PW
 - b. To Change Remote Parameter
 - 2. Play List [AU] Track [pg.21](#)
 - 3. Overwriting an Automation [pg.21](#)

III. CV Mode Settings (MIDI →CV) [pg.22](#)

- A. Gate + CV Jacks [pg.22](#)
 - 1. MIDI Sources [pg.22](#)
 - 2. VCO Selection [pg.23](#)
 - 3. Glide Options [pg.23](#)
 - 4. Merging MIDI / LINK Inputs [pg.23](#)
- B. CC Jacks (Output) [pg.24](#)
 - 1. MIDI Sources [pg.24](#)
 - 2. CC CV Function [pg.24](#)
 - a. Velocity
 - b. Velocity + Envelope
 - c. Envelope
 - d. MIDI CC to CV
 - e. Trigger Outputs
 - f. CV Transpose/Automation Outputs
 - 3. MIDI CC & Envelope Options [pg.24](#)
 - 4. Merging MIDI / LINK Inputs [pg.24](#)
- C. Drums Mode [pg.25](#)
 - 1. MIDI Sources [pg.25](#)
 - 2. Drums Channel [pg.25](#)
 - 3. Drum Layouts [pg.25](#)
 - 4. Trigger Time [pg.25](#)

III. CV Mode Settings (MIDI →CV) cont...

- D. Order Button (Chords) [pg.26](#)
 - 1. Stacked Notes→CV Jacks (Chords) + Settings [pg.26](#)
 - 2. Ranged Notes→CV Jacks (Splits) + Settings [pg.26](#)
 - 3. Cycled Notes→CV Jacks (Chords+) + Settings [pg.26](#)
 - 4. Random Probability Notes→CV Jacks + Settings [pg.27](#)
 - 5. Arpeggio Notes→CV + Settings [pg.27](#)

IV. The Play List Editor Grid [pg.28](#)

- A. Description [pg.28](#)
- B. The Play List Pop-Up Buttons [pg.28](#)
 - 1. Arming a Block [::ARM::] [pg.28](#)
 - 2. Adding a Block(s) [+ADD NEW+] [pg.28](#)
 - 3. Adding a Conditional Block [+ADD COND] [pg.29](#)
 - 4. Edit a Block / Track [--EDIT→] [pg.29](#)
 - 5. Adding a *PLFX* to a Block [*PLFX*] [pg.30](#)
 - 6. Transpose a Block [TRANSCOPE] [pg.30](#)
 - 7. Insert an Empty Cell [+ INSERT] [pg.30](#)
 - 8. Remove a Block or Cell [- REMOVE] [pg.30](#)
 - 9. Delete a Block [:DELETE:] [pg.30](#)
 - 10. Set Block Selection Fill Size [FILL:nn] [pg.30](#)

IV. The Play List Cont...

- 11. Shift Blocks Up or Down [SHIFT +/-] [pg.30](#)
- 12. Copy Area of Blocks [:COPY:] [pg.31](#)
- 13. Paste Area of Blocks [:PASTE:] [pg.31](#)
- 14. Solo Selected Track [SOLO] [pg.31](#)
- 15. Mute Selected Track [MUTE] [pg.31](#)
- 16. Record onto Selected Track [*RECORD] [pg.31](#)
- 17. Turn Main Loop On / Off [LOOP:OFF] [pg.31](#)
- 18. Recall Play List (Undo) [<<RECALL] [pg.31](#)
- 19. Cancel [CANCEL] [pg.31](#)
- 20. Exit Play List (+notes) [::EXIT::] [pg.31](#)

V. MIDI Remote Control [pg.32](#)

- A. Universal Remote Control [pg.32](#)
 - 1. MIDI CC or MIDI Notes? [pg.32](#)
 - 2. MIDI Learn Method [pg.32](#)
 - 3. List Program Method [pg.33](#)
 - 4. Global Learn or Song Project Learn? [pg.33](#)
- B. Track Remotes [pg.34](#)
- C. Remote CC TRAX Step Control [pg.34](#)
- D. CV Remotes (CV Inputs) [pg.34](#)

VI. Envelopes [pg.35](#)

- A. Settings [pg.35](#)
- B. ADSR EDIT an Envelope [pg.35](#)
- C. CV Draw an Envelope [pg.35](#)
- D. Parametrically Draw an Envelope [pg.36](#)
- E. Copy From... [pg.36](#)

VII. Utilities [pg.37](#)

- A. MIDI PUSH Button [pg.37](#)
- B. Tune Button [pg.39](#)
 - 1. Fine Tune Jacks [pg.39](#)
 - 2. Set Zero-Volt Note [pg.39](#)
 - 3. Select VCO Calibrations [pg.39](#)
 - 4. Auto-Calibrate to VCO [pg.39](#)
- C. Clock Button [pg.40](#)
- D. Transpose Button [pg.41](#)
- E. Select Bus Button [pg.41](#)
 - 1. As Master [pg.41](#)
 - 2. As Slave [pg.41](#)
 - 3. As Auto [pg.41](#)
- F. SAVE Button [pg.42](#)
 - 1. Save: Edit [pg.42](#)
 - 2. Save: Initial (Song:00) [pg.42](#)
 - 3. Delete (Song Project) [pg.42](#)
 - 4. Save As... [pg.42](#)
 - 5. Re-Start [pg.42](#)
 - 6. Settings [pg.43](#)
 - a. Settings Menu [pg.43](#)
 - b. SYSEX's [pg.44](#)
- G. Quick-Box Edit Mode [pg.46](#)

VIII. Appendices, Specifications, Trouble-shooting [pg.47](#)

[Specifications](#)

[Sequarallel MIDI Implementation Chart](#)

[Remote Control Implementation](#)

[Trouble-Shooting](#)

[Addendums](#)

I. Introduction

Congratulations on your purchase of the SDS Digital Sequarallel MIDI - CV Sequencer module!

If you want to convey complex sequences and DAW like control to your modular system without needing a computer then this is the right module for you!

The intuitive display places the power of a module 3 or 4 times larger into the 10HP real-estate category, and minimizes things you need to remember, thanks to the SDS Digital & K innovation of on-screen buttons called "Quick-Boxes" or QB's for short. As the name suggests, actions to modify and control a running sequence can be quickly navigated to without menu-diving or a PH.D. in acronyms. They are formatted in a logical and useful fashion with the more used buttons on top, descending to the lesser used ones below. Most buttons can be excluded, or re-arranged dynamically.

-What can this module do?

The Sequarallel can play any MIDI file you record into it from either a DAW sequencer, a keyboard, or a controller, then be divided up with loop markers, each with it's own note altering FX. These "Song FX" bundles with modifiers such as transpose, scales, note mirror / limiting / re-triggering can be applied to other on-board sequences so they may all follow.

Every type of Sequencer has FX and FX bundles that can be applied per sequencer or per events in a Play List, or even per note in the trackers. These FX can be tweaked live or assigned to a MIDI remote control using the Learn method.

A complex sequence can be built up by Layering live recording, sequencing Layers opted in as steps, over-dubbing tracker sequences, remotely tuning tracker steps, or even just manually adding notes. Any MIDI source or channel combination can then be assigned to the 4 channels of gate/CV output jacks, along with MIDI CC's or internal custom envelopes to the 6 CC CV jacks. All MIDI commands will be recorded, thus can be applied to outputs from the sequencers.

In total, up to 5 trackers, 32 Layers, 6 envelopes, and a MIDI Song, can play at once, all in sync to your clock input from the rack or a MIDI source, or on it's own learned / set BPM. A virtual DAW! -This is just a brief coverage of capabilities ;)

-Why do I need this module?

In the least, the Sequarallel can be used as an archive of base sequences to start off any modular performance. How you build onto the sequence is up to you.

A good example is using the Sequarallel to store different 12 trigger drum patterns.

MIDI isn't even required, but patching many percussion modules is made easy with the DRUM mode's note# or percussion display name option. A grid of 3 x 4 boxes appears with MIDI note numbers like 36, 38, 43 etc. which is a completely configurable layout. Up to 8 drum layouts can be stored in a Song Project, and up to 88 unique patterns/sequences, some up to 64 steps, some any length or cadence, some filtered from a larger MIDI file.

Another example of starter sequences would be recorded bass sequences cut up into loops, recorded into individually mutable Layers, or recorded / edited into multiple trackers. All sequences are accessible and can be placed in any order into a Play List

-How Long Can a Sequence Be?

A recorded song, depending on complexity, can be 7 to 20 minutes long. Sequences from Loops created from that can be variable and generative in their own right as the Play List tracks individually progress. If the trackers are sequencing various phrases, then the Song Loops apply transposition or scaling, this can completely change the trackers and any Layered MIDI recorded. In addition to this, automation clips can further build on variations, FX tweaks, and switch outputs etc. So unique play time is theoretically infinite!

-Can I Use the Sequarallel to Play and Record Music Along with my other Modular Sequences?

Yes, totally. Simply provide the Sequarallel with a clock, Turn on a Layer Record, and start playing your MIDI keyboard or controller. The Layer sequences can be built upon, extended, individually muted as part of a larger sequence, or removed, all in real time. The CC5 & CC6 CV inputs can be configured as MIDI Gate/Note to record from a modular sequencer.

-Can this module recognize 96PPQN?

Not at this time. This is planned for a future update once it has been decided how to implement it in a useful way. One can still record 96PPQN MIDI though no problem. The work-around is simply regard the bars as beats, and quadruple your modular clock speed of course! This can be better for odd time signatures in the Play List too.

-Can this module link with another Sequarallel?

Yes. 2 Sequarallel's can be LINKed together behind the panel to work together to expand MIDI2CV by simply forwarding MIDI to the second Sequarallel. All MIDI input ports, merges, and output ports have channel filtering so a custom mult (up to 3) from the LINK output could be used also to drive single-channel synths or modules etc.

The Sequarallel also has Eurorack Select Bus on the PSU header as master or slave! Daisy chained Sequarallel's could all follow the master's Song Project selection, thus loading the appropriate CV Mode settings.

Enjoy your Sequarallel!!!

Sandy Sims, SDS DIGITAL

Before continuing, here is a short glossary to help with shortened terms used in this manual.

List of terms / conventions used in this document

QB

Quick-Box Button. Appear on main screen and in editors. These can be scrolled through and selected.

Hold

This is to push and hold the encoder knob for > 3/4 second to access menus and lists.

Holding > 3/4 second will exit any menu or list as long as not on a pop-up QB (like in the editors which have an EXIT QB)

Under or Behind the QB

This is a reference to what screen will open when a QB is held >1 second

Click or Enter

Pressing the encoder knob switch

Double Click

Two successive presses on the encoder knob within 3/4 second (like a mouse)

Triple Click

Three successive presses on the encoder knob within 1.5 seconds (*only used in TRAX Editor*)

Song

1) Project or workspace. (Song Project) -or- 2) The main MIDI Song recorded.

Scroll

Rotating the encoder knob to point to a QB or item in a list, or setting a value.

Drop-down

This refers to a QB that unfolds into several to scroll through and select options.

Pop-Up

This is a window that appears within a grid or menu. It will contain QB Buttons.

P or S Button

Refers to the Play or Stop buttons on the panel. Pressed together arms to Record main Song.

[---]

Denotes a Quick-Box Button, the way it appears on the screen

nnn

Denotes a number of 1, 2, or 3 digits, usually as appears on screen

xxx

Denotes a non-numeric option name such as "SIZE" or "INPUT" with explanatory list following

Meter

This is an indicator in a Layer/TRAX/SongFX QB. These are pseudo VU meters that use the note velocities, but if the QB only has constant controllers (CC/PW/AT) recorded (i.e. with Layer QB) a small block will indicate relative position of control.

A. The Panel & Backplane

The Sequarallel panel has been laid out in a convenient and easy to see format as an 8HP module. The encoder knob is right of the screen to cater to mostly right handed users, but is high enough for left-handed use without obscuring the screen. As some functions require both of the buttons be pressed together, the buttons are close enough together to press both with one finger, but far enough apart to press each individually.

The OLED Display:

By default, the display adds 18 buttons, called “Quick-Boxes”, or QB's, to the panel for ample control of how the sequences play. QB's can toggle states, allow parameter adjustments, open a series of QB's, or enter into editor grids or settings. This is apparent by the way the QB / display will change when pressed.

On the left side Notes are displayed vertically as sent to jacks rows, or in Drum Mode, a grid of 12 boxes, each with the MIDI note number for a percussive element that highlight when the corresponding jack is at a logical high state.

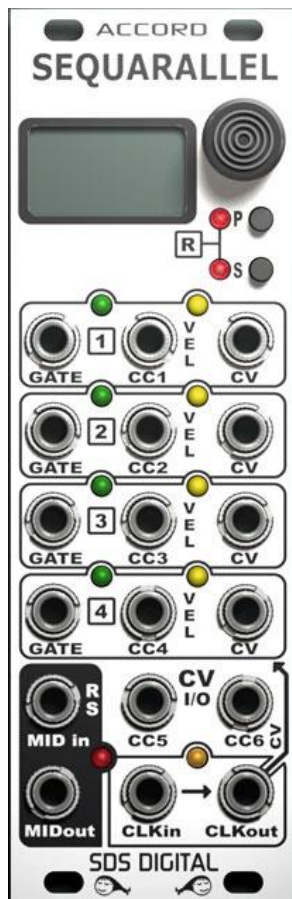

Encoder Knob:

The encoder knob is used for selecting Quick-Boxes to enable/disable functions, change settings, or, if held, to enter pertinent settings.

P & S Buttons:

The P button is primarily to arm Play mode, while the S button is primarily to Stop Play or abort Recording. Pressing the P button arms to Play on next Clock. If both P & S buttons are pressed together, main Song Record mode is armed to record/initiate a project.

Main Jacks Rows:

The top 12 jacks are arranged in four rows of 3 jacks each. Each row, or CV Channel, has Gate (trigger), Velocity/CC2CV/Envelope(CC1-4), and CV (1V/octave) bipolar outputs. During Drum Mode, these 12 are arranged as numerically descending sets of 4 starting with the left top-most jack.

CC Jacks:

The 2 CC jacks below the main 12 are I/O assigned by user. These jacks as outputs can be assigned any MIDI CC on any MIDI channel regardless of chords mode or drums mode setting.

As inputs, they can send MIDI CC's, PC, Pitch Bend, or control Loop, Jumps, transpose, Portamento, Channel Modes and more.

MIDI in Jack:

The MIDI in jack is used for auditioning MIDI through to the output jack, recording, and with a mono T-S plug, for triggering Reset of TRAX sequences to sync to the rest of the system patch, or auto-calibrating a VCO.

MIDI out Jack:

MIDI from sequences will merge with MIDI input and LINK input(backplane) to be output here.

Panel LED's:

The green LED's are Gates, while the yellow LED's are analogous to the +voltage on the C1-4 jacks. Amber is Clock I/O and Red is MIDI Out.

Clock In/Out Jacks:

These jacks are obviously for Clock I/O. To get into sync with the rest of your patch, Clock In is used. If you want to source the patch with a clock from MIDI or internal BPM setting, then Clock Out can be used to get the MIDI clock for modular use.

Clock Input always has priority over MIDI input.

The Clock Output, when using a Clock Input, becomes an Analog CV input like CC 5 & 6. This is a hidden feature that, along with CC 5 & 6, can be useful to control internal functions remotely. It can also be configured to be a Loop Trigger output.

MIDI LINK I/O

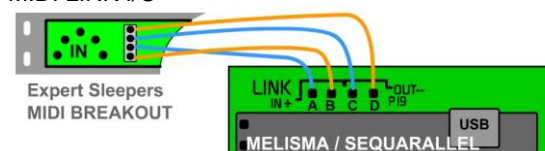

At the top-back of the module is the auxiliary MIDI I/O referred to as LINK Input / Output. The pins are as follows:

- A - LINK Input (+) common to optical isolator { i.e. Korg TRS Ring }
- B - LINK Input (-) signal to optical isolator { i.e. Korg TRS Tip }
- C - LINK Output (+) 100 ohm driven @ 5V { i.e. Korg TRS Ring }
- D - LINK Output (-) 100 ohm signal { i.e. Korg TRS Tip }

As the inputs A, B are optically isolated, hooking them up wrong won't cause any damage. The output pin C should not be shorted to ground for prolonged periods as this may overheat the regulator.

If you're not sure which direction to connect, simply try one, then the other.

*The USB jack is delicate, please use caution when connecting for a Firmware update

B. Quick-Box On-Screen Buttons Guide

This is a quick reference guide to each of the QB's, what they are for, and what's behind them. See linked sections for a more in-depth description of the QB and it's associated menu / list. ([▼](#) quick-link to topic)

Quick-Box:	Function	Menu / List Under QB (hold 1 second)
[LOOP:OFF]	Turn on / Off Play List Looping.	Add Song Loop Markers and set Song Start / view.
[JUMPTO:n]	Will Jump to a Play List Row or Group of blocks. Groups must be isolated by space on entire row.	Select Jump To Rows 0-63, or Groups "G1"+ To display in the JumpTo Quick-Box
[TRANS:+nn]	Master Transpose QB.	Set what transpose can adjust, Song, Trax, MIDI/LINK in. Set Range and Drums Blocking. ▼
[AUTO-REC]	Use to record Automations & set bars size, select AUTO # to record over.	None (see PL [AU] track→Edit to set automations used)
[:SONG FX:]	Apply Song FX to presently playing Song Loop. QB displays present Play List row and FX# Drops-down to adjust other Song Loop FX. Quant, Limit, Length, Levels, Scale, FX-Seq#, and Mirror	[:SONG FX:] Set transpose/Apply,FX#,Min Loops etc [SCALE:xx] Set up User Scales & Apply To. [FX SEQ:n] [FX-MOV] Set up Sub-Sequencer controls [MIRROR] Set Note Mirror limits, oct. step mode ▼
[CV MODE:n]	Select one of 4 CV Mode jack presets	Settings for all (output) jacks can be made here.
[DRUMS n]	Select on of 8 Drum Mode Layouts	Drum Settings, channel, and Note#'s to 12 Jacks list. ▼
[ORD:STACK]	Select method of handling MIDI Chords to Jacks.	Stack Release, Time, Overload options
[ORD:RANGE]	Each has it's own menu to set limits and timings.	Set 3 Note Range→Jack Points
[ORD:CYCLE]	Not used when in Drums Mode.	Set Cycle Direction, Minimum & Release Times
[ORD:RANDM]		Set Probability for each jack
[ORD:ARPEG]		Set up the 4 CV Arpeggiators ▼
[TUNE: +nn]	Set All CV Jack's Tuning (together)	Set Each Jack's Zero Volt Note#, Fine Tuning Auto-VCO-Calibrate and naming of calibration. ▼
[ENVELOPES]	Drop-Down to select Envelope Menu, ADSR Editor, CV Drawing, Parametric Drawing, and "Copy From" other Song Project.	Envelopes Main Menu opens quad viewer to select. Set Envelope Size, Trigger Source, Output Jack, and MIDI Output. CV Mode can also trigger env. ▼
[LAYER ADD:]	Drop-down to Record+Append, or adjust Layer FX: Levels, Quant, Limit, Mirror, Scale, Transpose. Kill Last, or Remove QB (last only) & Exit QB	[LAYER n] Enter a Layer Sequencer [SCALE:xx] Set up User Scales [MIRROR] Set Note Mirror limits, oct. step mode ▼
[TRAX: n]	Drop-Down to Trax Editor, Record, or adjust FX: Levels, Swing, Mirror, Scale, Limit, & transpose. Delete Trax QB (last only), & Exit QB	[TRAX EDIT] Select a Trax Letter & Enter Editor [SWING] Enter Trax Swing Sequencer / Mask [[SCALE:xx] Set up User Scales [MIRROR] Set Note Mirror limits, oct. step mode ▼
[CLOCK:/nn]	Set Clock input division.	Set Clock Options (BPM setting / Use internal) ▼
[MIDI PUSH]	Send all MIDI setup data for this Song Project	Set CC5/CC6/CKO Jacks I/O direction & Functions Push MIDI Include Options & MIDI CC Values Set Instruments (PC) on 16 channels Turn on/off MIDI/LINK I/O/Merge Channels ▼
[REMOTE:nn]	Set Universal Remote Channel	MIDI Remote CC/Note List Editors ▼
[SELBUS:nn]	Set Select Bus number for this Song Project Set Select Bus number that will be sent with project load (if master and option enabled)	Select bus Settings and options. Master, Auto, Slave Mode → Remote Control ▼
[SONG:nn]	Select to load a Song Project 00 - 61	Edit Song Names List ▼
[PLAY*LIST]	Enter the Play List Grid (no need to hold)	Play List Editor ▼
[SAVE:INIT]	Drop-Down to Save Initial Song:00, Save Edit of any Song, Save As..., Delete Song Project, Restart, Settings (global)	[SETTINGS] Enter Global Settings for Sequarallel. Set Screen Saver option, SysEx Save / Load, Scala, Edit QB's (local), Timing etc. ▼

*Edit QB's (in Settings) can remove unwanted QB's you may not use. This is not Global but per Song Project.

C. Song Projects + Song:00

The Sequarallel can hold up to 61 Song Projects, not including the initial Song:00.

Song:00 can be used as a temporary storage for the initial start of a Song project. At some point you may want to permanently save your creation, so the [SAVE AS..] QB (drop-down from[SAVE:EDIT]) can be used to save the project to Song:01 to 61.

To save modifications to Song:00 you must select [SAVE:INIT] then set to "YES" and hold for 1 second. This is to avoid accidentally saving a song project to the initiator Song:00. If you hold for >5 Seconds, then Song:00 is set to factory settings.

If you want to save changes to a Song Project, use [SAVE:EDIT] . This can be used while playing or stopped, but while playing will take about 10 seconds after you click it, so try not to make any more changes within that time or they might not be saved.

* On shipping, Song:61 will have some TRAX drum loops for you to use. It can also be played. (see the [site](#) for possible update / info)

II. The Sequencers

The Sequarallel has 3 main types of Sequencers, not including the SongFX Sub-Sequencer, TRAX Note FX mask Sequencer, and Layer Step Sequencer. The MIDI Song Sequencer uses Loops, while the TRAX Sequencers use steps, and the Layer sequencers use recorded loop sized Layers.

A. MIDI Song Sequencer / Looper

The Song Sequencer is intended to record a MIDI Song from some other sequencer (HW or DAW) to be divided up into Loops to tweak with MIDI FX. Each Song Loop can have it's own FX along with it's own transposition and scale. These two can be sent to control the other types of sequencers, and Layer Steps can even use the presently playing Song FX like the Song Loop.

Even if the Song is an empty (default is 96 bars long) it can be used to control other sequencers in a cohesive way, so they all match scale and / or transposition, as controlled by the Song Loops.

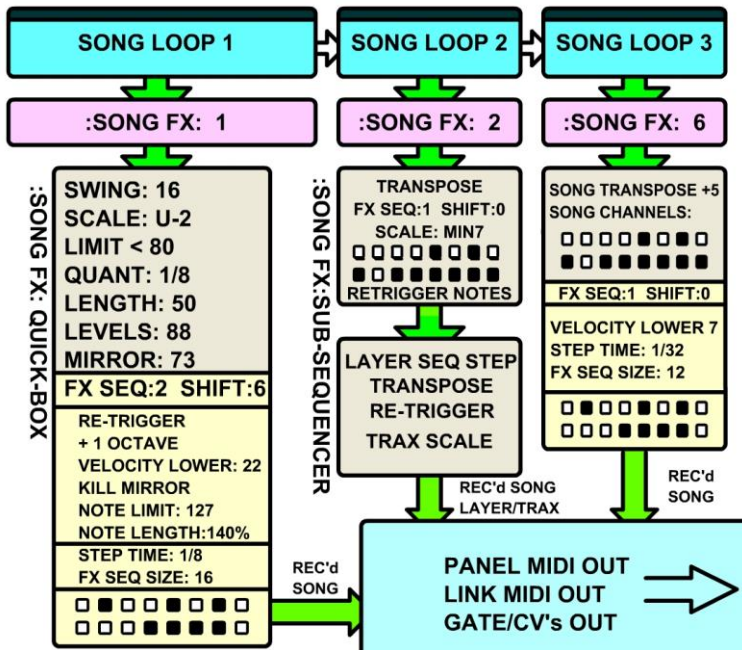

The diagram (left) is an example of how the other Sequencers could be controlled by SongFX with or without recorded MIDI in the Song.

Each Song Loop in the Play List can have it's own SongFX bundle. By default, the SongFX# matches the Song Loop#, but each can be assigned any of the 17 SongFX bundles.

In addition to this, SongFX#'s can be dependant on which cell of the Play List it's in. So the Same Song Loop 1, for example, can call SongFX# 1, then SongFX# 3, then SongFX# 5, etc.

If the "Song" is just an empty frame, then It's easier to allow the SongFX# to match the Song Loop#. The "dummy" Song is 96 bars that can be divided into Loops.

SongFX can send Transpose and Scale to modify all TRAX and/or MIDI Layer Sequences. The Layer Bar Step Sequencer can opt-in to use all SongFX (except Time Quantize) for the duration of a Step. This can be seen as automation, but there is also Automation track!

SongFX Swing setting affects all sequencers.

** TRAX QB's though have their own Swing setting that will add/subtract from the Song Swing, with a Swing Subsequencer!*

1. Recording a MIDI Song For Looping

While a Song can simply be downloaded from a MIDI Site and recorded in, there may be some things to consider.

- Does what you want to loop align to a bar? Some Songs have lead-in notes that will be chopped if looped.
- Is the song basically 4/4? 3/4 and other time signatures will work but may limit where Loops can be placed.

The best way to find out is sometimes just recording it in and trying it out! ..But if you're recording from a DAW that has control over where notes align, quantization (to get rid of a swing in notes) or device specific glide control, it may be a good idea to edit it first. The MIDI Sequence can be played through the Sequarallel too.

a. MIDI Setup + Planning

First, make sure your source is plugged in to the Sequarallel's MIDI input. For best results make sure your source is outputting a MIDI Clock (not MTC) and transport messages, i.e. Play / Continue / Stop. This will ensure the Song is recorded properly.

If you want to define loops in a DAW software, just place a note # 121 in the bar you wish to start the loop. The next note # 121 will end it and start a new loop, etc.

b. Clocking

As mentioned above, the preferred method to record the main Song is with a MIDI Clock. Using a modular clock or internal BPM clock, and no MIDI clock messages will ensure mayhem if not synced to the source sequence. This can produce some interesting results though so don't write it off completely.

If you want to just record some piano playing along with a modular clock, I would more recommend using Layers as it's more flexible and less trouble to initiate. Song record can do it if you want an exceedingly long recording though.

If using modular clock to record a song, it's best at 1/4 measure timing, or 1 clock per 1/4 measure, or 1 clock per 4/4 beat. The reason is each clock is divided up into MIDI clocks. If too slow, then the note timing will sound quantized, if too fast then bars will fly by quickly requiring larger sized loops and a faster clock for everything.

2. Setting Loop Button Actions

a. Change what Loop Button displays

When the cursor brackets are not placed over the LOOP during Play, the Bars & Beat count (default), or bars until end of Loop can be displayed. Under the **[LOOP:OFF]** QB scroll down to 2nd entry and click on **DISPLAY:xxxx** to select on of the following:

BARS+BEAT	Will display BAR:nnn:b where nnn = Song bar # and b = beat 1 to 4.
TO MARKER	Will display UNTIL:nnn where nnn=bars before end of present loop
NONE	LOOP QB will always display Loop on / off status

b. Set What Will Loop

By default, LOOP:ON will hold all elements in the Play List to the present block, thus looping, along with the Song. Sometimes this may not be preferred so TRAX and / or Layer sequences can opt out. Click on **LOOP SONG:+ xxxx** and select:

NONE	Only Song will loop when Loop is turned on, TRAX & Layers will step through Play List
TRAX	TRAX Trackers will loop with song when Loop is turned on, Layers will continue
LAYER	Layer Step Sequencer Blocks will loop with song when Loop is turned on, TRAX will continue
BOTH	Both TRAX Trackers and Layers will loop with song when Loop is turned on (default)

3. Adding Song Loop Markers

Once a song has been recorded in and / or aligned to measures, you'll likely want to add Loop Markers. If the song was recorded from a DAW you may have added note 121 markers to define these, otherwise you'll have to add them within the Sequarallel's UI. Markers can be added under the **[LOOP:OFF]** QB. There are 3 ways to add/remove Loop Markers:

a. Manual entry using "Add"

Scroll to the bottom of Settings under the **[LOOP:OFF]** QB until you're at LOOP:nn ADD:

Clicking on this will add a marker at 4 bars after the previous position.

If you adjust the Loop Size away from 4 bars, then the following Loops created will have the new size.

If playing the song, any Loop while selected will audition so you can get the loop points right! Loops can be any size, but remember one will affect the next's start point etc.

b. "Delete All Loops & SongFX"

Under the **[LOOP:OFF]** QB, scroll down to **DELETE:ALL:SONGFX** and click to instantly delete all Song Loop Markers and associated SongFX. This would be used to re-use a recorded song from scratch, usually when "Saved-As" a new project. Warning: this cannot be undone so make sure you have saved original if you want to keep it!

c. "Insert Markers" to Divide Loops

Under the **[LOOP:OFF]** QB, scroll down to **INSERT MARKERS** and click to toggle on (will highlight)

Scroll down to the **LOOP:nn** you want to insert within and click. The old Loop will be cut in half to accommodate the new Loop. The size can be adjusted but don't forget to return back up to disable **INSERT MARKERS** first!

d. "Delete Markers" to Combine Loops

Under the **[LOOP:OFF]** QB, scroll down to **DELETE MARKERS** and click to toggle on (will highlight)

Scroll down to the **LOOP:nn** you want to remove and click. The Loop below it will combine with it making a larger Loop

This does not delete SongFX assignment, but rather preserves them according to their position in the Play List, i.e.

Loop#1=SongFX#1, Loop#2=SongFX#2, Loop#3=SongFX#3. Delete Loop#2 joins #3 so new Loop#2 will have SongFX#3.

e. Trimming last Loop With "Song End"

Scroll to the bottom of the **LOOP:nn** list and you'll find **SONG END:nnn**. This is to set the loop point of the last loop if you wish to use it as perhaps it's not even or has "empty" bars etc. The range is 1 bar above the highest Loop marker up to true length before record ended. The recorder will try to trim the end if was stopped via a MIDI Stop message, but otherwise there may be a few empty bars or extraneous notes.

Notes:

1-Any Loops created will be added to the Play List in Series starting from the last block in the group that is presently armed to play. If the location would cause a group to join another, then the following group will be appended instead.

2-Any Loops Created will duplicate Loop 1's SongFX. This way it can be set beforehand, then duplicated to all that follow.

So if you plan to apply an FX, i.e. swing, throughout the loops, it's best to set up SongFX #1 before creating loops.

3-Any Loops deleted will renumber the ones after, so some editing may be required in the Play List...

i.e. 2, 3, 4, 5, then delete 3 will result in 2, 3, 3, 4. (loop 5 became loop 4 etc.)

4-Click **[EXIT]** or **press & hold encoder** to return to the Main Screen

4. Applying Song Loop FX

II. 4.

Setting up a Song Loop's FX, or SongFX for short, is easy as each Loop created will by default be assigned a SongFX#1-17. This can be changed of course, *i.e. Song Loop 3 could be changed from SongFX#3 to SongFX#7 at a point in the Play List.* The [SONG FX:] drop-down QB has all of the magic! This can be accessed from the main screen with a click, or from the Play List by selecting the Song Loop Block you want to edit.

**Selecting a Song Loop in the Play List during Playing will play it next.*

Scrolling over the QB in main screen will display the presently playing Song Loop # and it's SongFX#.

Once in the drop-down you can scroll through each of the following to make settings for *this* Song Loop. Some of these drop-down QB's have settings under them:

a. Song FX Settings

Press and hold to enter the SongFX main Settings. This is where a SongFX# can be assigned to *this* Song Loop #. The Settings are as follows:

PL:pp LOOP:nn FX:mm	Shows / select SongFX#. pp = Play List Row, nn = Song Loop#, mm = SongFX#
FX EDIT:COPY	Action to perform→ Copy this FX, Paste This FX, Reset this FX, Cancel (to exit)
FX TRANSPOSE:+nn	Transpose this Song Loop (or Layer / TRAX) + / - 48 semitones
TRANS:APPLY TO:xxx	Apply transpose to TRAX, LAYER, BOTH or NONE.
MINIMUM LOOPS:	Set minimum number of times this SongFX# will loop the Song Loop. Up to 96.
MAXIMUM BARS:	Set maximum bars that will play from this Loop. Starts at 1 bar.
EXIT	Exit back to SongFX drop-down QB
[01] [02] [03]	Toggle MIDI Channels on and off. Recorded Song Channels Only. <i>* To enable / disable MIDI Channels at Ports, see end of Sect. VII. A. MIDI PUSH</i>

b. Swing (Global)

This is the SongFX#'s Swing control. 50% is normal maximum but this will go to 90%. This swing setting will be applied to both recorded Layers and the TRAX trackers as is connected to the master progression of sequences. As TRAX has it's own swing, one must be careful when used with extreme settings or tracker step rate may become unstable (unless you want this!)

** SongFX Swing setting will affect tracker NoteFX Echo FX timing based on point of swing TRAX note played.*

c. Scales + Settings

Select [SCALE:xxx] to set a scale for the present Song Loop # (and Layer / TRAX if enabled). Maj, min, Maj7, min7 presets are followed by user settable scales (up to 4) that can be modified under this QB in Scale Settings:

APPLY SCALE TO:xxx	NONE, TRAX, LAYER, BOTH. Other than this Song Loop, apply scale to...
SCALE DRUMS? NO	YES: Rarely used but will scale the defined percussion channel (for variation?)
SCALE EDIT:n	1 to 4. Select a user scale to edit below.
[C] [C#] [D] [Eb] . . .	Toggle notes on / off to add / mask notes that will play from the SongFX#.
...No Exit: (Hold encoder to exit)	

d. Limit (Notes)

Select [LIMIT<128] QB and scroll left to set note # limit below setting made, or scroll right to set limit above setting made. Limit follows Mirror modifier so can be used to trim off extreme highs or lows sometimes produced with full ranges.

e. Quantization

Turn on a time [QUANT:n] to move notes tightly into beat divisions. This can quantize to 1/8, 1/12, 1/16, 1/24, and 1/32.

f. Length (Notes)

The [LENGTH:--] setting will act as an attenuator from 1 to 100% of original note lengths. Note that this setting can create staccato or reduce re-triggers if turned on in FX Sub-Sequencer. The Sub-Sequencer's Length control can increase lengths to 150% of original when a step is not masked, which can increase re-triggering. See SongFX section 5. a. below.

g. Levels (Velocity)

The [LEVEL:nnn] gain setting can boost velocities by up to a factor of 150%, or attenuate right down to near nothing. Many times when using re-triggering of there's other sequences playing, it's good to reduce the overall level to be softer. Don't confuse this with MIDI channel level or pressure (*i.e. CC#7*) which can be set from with the [MIDI PUSH] QB

h. Mirror (Notes) + Settings

The Mirror Notes FX [MIRROR:nn] will take notes above your setting and place them below at the same distance, then take notes below your setting and place them above at the same distance. This tends to turn consonance into dissonance, and visa-versa, but also changes a familiar song into something entirely new!

Under this QB are a few settings for Mirror:

▶ MIRROR:nn	Duplicate control to adjust while in these settings.
▶ MIRROR:STEP:OCT:NO	YES: Will step Mirror in Octaves (6's) so following adjustments sound like inversions.
▶ LOWER LIMIT:nnn	Lower cut-off to Mirror. Notes lower will just pass through.
▶ UPPER LIMIT:nnn	Upper cut-off to Mirror. Notes higher than this will pass through.
▶ EXIT	Exit back to Mirror QB

5. The Song Loop FX SEQ Mask Sub-Sequencer

II. 5.

After Selecting a Song Loop Block or [SONG FX] QB in main screen, scroll down to [FX SEQ:n] to select a sub-sequencer number, or hold to enter it's settings:

a. Settings + FX

Hold [FX SEQ:n] to enter settings listed as follows:

- ▶ **FX SEQ:SELECT:n** n = one of 4 sub-sequencer settings for this Song FX#
- ▶ **RE-TRIGGER? NO** YES: Will re-trigger notes with the sub-sequencer steps that are not masked. (see below)
- ▶ **DRUMS TRIGGER?NO** YES: Will re-trigger notes on defined percussion MIDI channel (default: Channel 10)
- ▶ **+1 OCTAVE? NO** YES: Unmasked sub-sequencer steps will add an octave to following notes.
- ▶ **VELOCITY LOWER:--** Value subtracts velocity from notes played on masked steps, making unmasked steps louder.
- ▶ **KILL MIRROR?NO** YES: Turns off Drop-down [MIRROR:nn] setting for un-masked steps.
- ▶ **NOTE LENGTH:nnn** Value will set lengths of notes played during unmasked steps. **This can affect Re-Trig!*
- ▶ **NOTE LIMIT:nnn** Value will limit note# of notes by rolling octaves down during un-masked steps.
-
- ▶ **STEP:TIME:n/n** Sets Clock Division of sub-sequencer steps from 1/1 to 1/32 measure. Based on master clock.
- ▶ **FX_SEQ:SIZE:nn** Number of steps in sub-sequencer from 3 to 16.
- [01] [02] [03] . . .** Toggle masks in steps on / off. Black = masked, White = active (un-masked)

The [FX-MOV+n] QB can also be held to enter these settings. Up to 4 different pages of settings per SongFX# can be set up.

Retriggering Notes:

Any Song (or Layer if enabled in Layer Step) note will be repeated with un-masked sub-sequencer steps as follows:

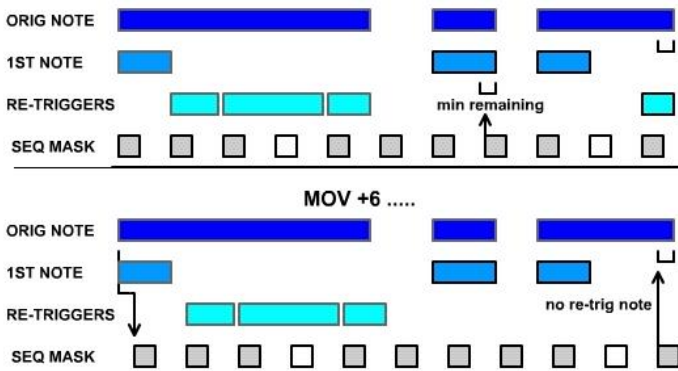

Notes that are within 1/32 time remaining will be re-triggered to play until end unless re-triggered again. Only sub-sequencer steps that are not masked will re-trigger notes. This can create a rhythm where there was none (especially if notes are not synced with clock!

b. Move (Mask)

If the [FX-MOV+n] QB in SongFX drop-down is set higher than zero, the sub-sequencer is shifted by the value (in 1/24ths of a quarter measure) thus shifting the way notes play as shown. Note the last note's re-trigger doesn't happen as is past the minimum remaining note value at that point.

Re-triggering cadence will also be affected by swing setting so while swing is adjusted up, the [FX-MOV+n] settings may cause some undesirable timing but on the other hand can create some bizarre cadences!

Even small changes in the note length setting can completely change the way sequences play.

6. Applying Song Loop FX to Layer & TRAX Sequencers

II. 6.

As each Song Loop can have a myriad of effects applied, including transpose, it is preferable that other Sequencers can be affected by some of these if desired. This makes composing a great sound easy and fun. Even if you're not a great pianist or keyboardist (such as myself), new and interesting progressions can be mutated with SongFX controls over recorded Layers, or even TRAX tracker sequences.

** Note: Song FX Swing setting will affect both Layers and TRAX by default!*

*** TRAX Swing is additive or subtractive with Song Loop FX set Swing. It may null.*

a. Transpose

Transpose is obviously one of the most important modifiers to change. This switches the root of your sequence in a classic way without changing the relative chord(s) or arpeggiation progression(s). This may be to follow a melody if that's your style, or just to add variation.

Use one Song Loop's FX# to apply no transpose, while a second to shift everything up by 7 semitones. This is done in settings under the [:SONG FX:] QB. Make sure you turn on a target Layer, TRAX, or both with "TRANS:APPLY TO" setting.

b. Scales

Scale override is probably the second most desired across-the-board modifier to change. This applies the common scales Major / minor & 7's or up to 4 User Scales created by opting out notes of an octave.

So the above example can be further refined by scrolling the SongFX drop-down QB to [SCALE:xxx] and holding to open its settings to enable a target to apply Scale to, Layer, TRAX or both. Custom scales can be created here too, or one of the 4 standard scales selected from the QB after exiting settings.

c. Use Song Fx (Layer Sequencer)

Because the Layer Sequencers are similar to the Song Sequencer in many ways, Nearly all SongFX settings can be applied to any Layer Sequencer Step(s). In addition to the Transpose & Scale FX mention above, you may want to Re-trigger Layer notes along with Song Loop notes, or if using empty Song Loops, just as a control.

The Song Loop FX that can be received by a Layer Sequencer Step include Note Length, Limit, Level, Mirror, Sub-Sequencer modifiers.

In main screen press & hold a Layer QB to select a Layer Step Sequence you have created. Scroll to the step you want to apply the SongFX to. Click to horizontal and scroll left so row highlights. Double-click to open the Step settings. The header might read for example:

LAYER 2 SEQ1 STEP:3>

=====

▶ TRANSPOSE:nn

▶ LEVELS:nnn

▶ USE RE-TRIGGER:NO

▶ USE SONG FX:NO

▶ LAY SOLO:NO

▶ CHANNELS:ALL (original)

▶ EXIT

The arrow indicates that this step is playing now (if playing) and will hold on this step!

The following settings can be made from the Layer Seq. Step

Transpose this step. Will be added to any other transpose in effect

Set MIDI velocity levels as "gain" of this step

YES: Will use SongFX Sub-Seq. Note Re-Triggering. **Note: See next section d.*

YES: All SongFX modifiers will be applied to this Layer for this Step. *See Section B.3.c*

YES: Will Solo this Layer or add to any sequencer Soloing presently.

ALL, 1-16, NONE, MPE0/1. Sends all Layers in this Step to a MIDI Channel selected.

Exit back to Layer Step Sequencer Editor.

See [Section II. B. 3](#) for more in-depth look the Layer Sequencer Editor...

d. Use Notes Re-trigger

As mentioned in previous section, Re-Trigger can be used to bring a rhythm into a recording that perhaps has none, or to chop up long notes into shorter ones. To use SongFX Re-Triggering with a Layer Sequencer Step, the RE_TRIGGER setting must be YES in the to-be-used SongFX#'s FX-SEQ:n sub-sequence.

If the SongFX is primarily for a Layer Step, then tweak the sub-sequencer masking in the SongFX# while that step plays alone.

B. MIDI Layer Sequencers

II. B

Each Song Project can have up to 4 Layer Quick-Box Buttons. Each of these can record up to 8 Layers of MIDI on any channel. These Layers, denoted by Letters A to H, can be of varied size and are placed into Step 1 (initially) of a Step Sequencer. Each step can be up to 64 bars long with up to 8 Steps in a Layer Sequencer. There are 4 of these Sequencers per Layer QB. Each step can use any combination of Layer Letters A-H by turning them on or off in the step.

1. Recording MIDI Layers

The MIDI Layer will record any MIDI channel as long as it isn't blocked from an input port (see MIDI PUSH). All MIDI controller messages are also recorded which can give some interesting results when opted in or out of a Sequencer Step.

a. Bars Setting

In the main screen, scroll to a Layer QB and click to add or open drop-down. Scroll to **[L RECORD]** and click to set bars. The default is 4 bars. Click once bar count determined to arm for record. *Set to 4 bars for starters.*

In order to record the Sequencer must be Playing, so hit Play if it is stopped.

- The first MIDI note / PW / CC received will start the recording.

- Any more MIDI received after the 4 bars will create a new Layer and so on. The previous loop will be heard.

Layer record's started mid-way through a bars step may quantize oddly (**[QUANT] on) on the first loop. This is normal.*

b. Record Options

Scroll to **[L RECORD]** and press and hold to open Record Settings. Here you can set the following:

- ▶ **BARS:nn** Just like in QB (above) before record mode, bars can be set here.
- ▶ **REC UNTIL:xx** Record until no more notes (default), or only as a 1-shot once bar count reached record turns off
- ▶ **REC LAY MUTE:NO** Yes: will mute this Layer's layers while recording. Will un-mute once recording stops...
- ▶ **QUANT START:xxxx** Select Pre-record placement & timing method:

BARS If new record size < present Step size, then will quantize closest to Step start point, i.e. Step is at bar 14 of 16 bars, record size is 4 bars, so set start to bar 2. (this is default)

ZERO No matter where in Step record begins, start offset is zeroed to Step start. This means that on next step play could begin before Record is completed. Use REC LAY MUTE:YES to avoid this if annoying!

NONE No modifiers so Play of recorded Layer will begin at the point in a Step it was recorded at. This may cause a problem if a Step's size is changed to less than the record start point, & retriggered, thus it may never play.

- ▶ **CLOCK:START:NO** Yes: If Layer set to record & Play armed, will begin recording at first clock (**NEW V1.3**)

c. Append Option

This is a record option. If you keep adding notes past the record bars setting (i.e. 4 bars in last section) the record size will double. This will prevent a new Layer from being created. The append note must be before the 2nd "beat" of a 4/4 bar.

d. Removing a Layer

If you make a mistake in a recording (or more than one) the last recording can be deleted using the KILL LAST option in the Layer QB drop down. The KILL LAST option only saves memory if no other Layer QB's have been recorded to as it's a stack. To delete the Layer QB and start again, use REMOVE option.

2. Applying Layer FX (QB Button Global)

The Layer QB Drop-down shown above includes some Layer FX modifiers that will change any Layer of the selected Layer QB. All Layer letters playing will be affected by these.

a. Levels (Velocity)

Adjust to percentage of original Velocity, or increase by up to 50%. Default is "--" which is 100% of original level.

b. Quantization

Sets a timing quantization lock to nearest to set value. The ranges are 1/4, 1/8, 1/12, 1/16, 1/24, 1/32. If on during record, the initial playback once records a loop may sound different to the way it was played in as it will be re-aligning to quantized value.

c. Mirror (Notes) + Settings

Mirror setting changes all notes to inverse above and below your setting. i.e. if set to 60, then a note# 48 (C4) would be played as note 72 (C6). Hold to enter Mirror settings to change lower and upper limits to mirror, and Octaval step option (to remain on same tone thus acting as inversion when adjusting)

d. Scales + Settings

Scale setting will apply selected Scale to all notes played through this Layer. Press & hold to access settings for this Layer QB's Scaling. The TRAX / Layer user scales (1-4) can be edited here or corresponding numbered scale copied from Song FX. Note that Song Loop FX Scales with "send to" set to Layers will override this scale setting always.

e. Limit (Notes)

The Limit stops notes greater or less than the setting by wrapping them 1 octave. Notes are not lost, just limited. Scrolling down (arrow left) will set an upper limit, or scrolling up (arrow right) will set a lower limit.

f. Transpose

This will transpose entire Layer QB and will act as an offset of any other transposition combination from Layer Sequence Steps or a Song FX transpose send or just the master Transpose control.

3. The Layer Sequencer Editor

II. B. 3.

The powerful Layer Step Sequencer Editor / Arranger allows some recorded MIDI Layers to play while others not. Each step can have some FX applied, which will apply to all playing Layers in that step.

Hold encoder on [LAYER n] QB to enter Sequence Selector. Choose the Sequence you wish to edit. (Usually SEQ 1 if new)

#	BR	A	B	C	D	E	F	G	H
01	02	02	--	--	--				
02	08	02	04	--	--				
03	16	02	04	08	--				
04	--	--	04	--	08				
05									

The Letters A to H represent each Layer recorded. Under the Letters are the original sizes (in bars) of the Layers. The BR column is to set the step length in bars. Letters that are longer than the BR setting will either be restarted by itself in another step, looped, or will play out entirely. FX of the next step will be applied either way.

Each Layer Sequence can be up to 8 steps. Each Layer QB can have up to 4 different Sequences in the Play List. Scroll to bottom to exit.

a. Including / Omitting Layers

Assuming several Layers have already been recorded, (they will be included in a valid step) they can be toggled on / off by scrolling around the grid and double-clicking. If a Letter cannot be turned on, then it hasn't been recorded yet.

Empty steps (i.e. no layer letters turned on) can be used as pauses up to 99 bars.

b. Adjusting Step Sizes

To adjust a Step size, simply click H/V to scroll to it, then double click to edit. Step size need not match Loop sizes.

Any Layers larger than the step size will continue to play into the next step unless the next step also uses the same letter at which point the letter will simply re-start. Layers smaller than step size will loop within the step.

c. Applying Layer Sequencer Step FX

Each step has some unique FX that can be applied. As mentioned in **Section A. 6. c.**, SongFX can be applied to Layer Steps. To access the FX list, scroll left-most to the step number. This will highlight entire row. Double-click to open FX list.

This list of options is as follows:

- ▶ **TRANPOSE** Transpose all notes in layers in this step.
- ▶ **LEVELS** Adjust overall velocity gain of all notes in this step.
- ▶ **USE RE-TRIGGER?** If a Song Loop FX is playing it's Sub-Sequencer, it can also re-trigger Layers' notes in this Step (*)
- ▶ **USE SONG FX?** If a Song Loop FX is playing, use it's FX on these Layers in this Step.
- ▶ **LAY SOLO?** This Layer can join the Solo'd tracks, or be the solo'd track (Mute overrides)
- ▶ **CHANNELS** Select "ALL" to use original recorded channel(s), or pick a channel for them all to use in this Step.
- ▶ **EXIT** Return to Layer Sequencer Editor

** Note: Re-trigger option in SongFX Sequencer playing must also be turned on for Layer Note Re-Triggering to occur.*

Song FX?

When the above "Use SongFX" option is enabled, the following additional songFX will modify the way Layers in Step will play:

- MIRROR** SongFX QB Mirror setting (and limits) are applied to Layers
- SUB-SEQ KILL MIRROR** SongFX SEQ:n can kill mirror on unmasked steps
- LIMIT** SongFX QB Note Limit (> or <) Setting is applied to Layers
- SUB-SEQ LIMIT** SongFX SEQ:n overrides QB Limit setting with < setting in sub-seq
- LEVEL** SongFX QB Level setting is applied
- SUB-SEQ VELOCITY LOWER** SongFX SEQ:n will lower Layer notes during masked steps by set amount.
- LENGTH** SongFX QB Note Length attenuation is applied to Layer notes
- SUB-SEQ NOTE LENGTH** SongFX SEQ:n unmasked kills QB Setting and attenuates/gains Layer Note Lengths.
- +1 OCTAVE** SongFX SEQ:n unmasked steps add 1 octave to Layer notes during sub-seq step.

As SongFX are loaded in the Play List, these act as an automation of sorts to control potentially all Layers in a useful way.

SongFX also has Transpose offset and Scale application for all Layers and TRAX. These settings are global.

Experimental overlaps can produce some great results with even just a handful of loops.

Keep in mind the percussion channel of a Layer recorded can be changed by these FX. If you don't want this to happen, confine percussion to a different Layer QB.

CHANNELS: MIDI MPE:

If CHANNELS is set to MPE0 or MPE1 then all channels are merged, then sorted to 4 channels in the zone. Zone 0 is 2, 3, 4, & 5. Zone 1 is 15, 14, 13, 12. Channels are stacked but not searched, so if a note ends on channel 2, then next note may not be sent to channel 2. All CC's & Pitch Bend are sent to the highest (or lowest if zone 1) channel.

True MPE input (*), on the other hand, will be recorded by Layers as it is, on original MPE channels.

** Note: Quantized Layers will also have expressions quantized! Faster Quantizing, or none, suggested.*

Meters!

The mini meters below each letter give an indication as to what is playing in each Layer Letter according to velocity. A roaming block instead indicates there are just MIDI CC's or Pitch Bend. There can be both, which will switch between the two!

** Any Percussion (on drum channel) will flash very quickly except the "whistles" notes which can be held.*

C. TRAX Tracker Sequencers

II. C.

The TRAX Tracker Sequencers are one of the most powerful features of the Sequarallel. The trackers can be edited note by note, have several editing helpers, or can be recorded directly into via MIDI and some innovative over-dubbing and remote control features. These features are so useful that the Sequarallel could have stopped here, with just the trackers!

To create a TRAX QB Button, which can house up to 8 different sequences, in the main screen, scroll to [TRAX:ADD?], click it and select YES. [TRAX 1] drop-down QB will be created. The drop-down will be covered in [part 3](#) of this section.

1. Using the TRAX Tracker Editor (by example)

- To enter the TRAX Editor, Hold on the new TRAX 1 QB button then select [A] to enter editor.

or

- If you want you can name the new pattern first:

- 1) Scroll to EDIT NAME, then scroll to the pattern you wish to name, [A] in this case.
- 2) Scroll to highlight the letter you want to change, click to select a new letter, click to edit another letter etc.
- 3) Scroll across the name past the right end and cursor will exit. Turn off EDIT NAME if finished.



Populated TRAX Tracker Grid

Shown left is the TRAX Editor Grid. A new pattern will be empty as indicated by "--" throughout.

- Click the encoder to toggle between Horizontal & Vertical navigation.
- Scroll horizontal past the last column to open a pop-out list of buttons to assist with editing, make settings, or modify the way a pattern plays.
- Double click any cell of the grid to add a note. Scroll to a note. Click to exit & save it.
- Triple Click (shortcut) to edit a Note's properties. (See part b. below)
- Hold encoder anywhere on grid to exit the TRAX Editor. There is also an [EXIT] QB.
- Scrolling to the Step numbers column will allow entire row to be selected at once.

a. Tracker Settings (Setup)

TRAX Settings

Hold encoder down on [;SETUP:] to make Settings for this TRAX Letter. It's important to make these settings when creating the first TRAX Letter (A) as all following Letters created will use these settings as a default. Afterwards, these settings can of course be tailored for each Sequence. Here's a guide to Setup:

- ▶ **BOTTOM:** This is the first step of the sequence. This can be changed during play but will update on sequence roll.
- ▶ **SIZE:** This is the Size of the sequence in steps from 4 to 64. Default is 16 steps
- ▶ **CLOCK:** This is clock div/mult, compared to master clock, from /96 to *8. Default Clock is *2
- ▶ **MINIMUM BARS:** This sets minimum bars (4 beats) this will play in the PlayList. Default is 1 Bar.
- ▶ **MAXIMUM BARS:** This sets maximum bars that will play before resetting to start. Default is FREE (none)
- ▶ **CV GATE OUT:** Select a CV Row, or all 4 for multi-lane Steps, or none. Normally you will want to set as Row 1-4 for one TRAX#, but if using single lane then perhaps single row is better!
- ▶ **VEL OUT:** This is output to VEL Jack(s) if velocity selected in CV MODE. Set to **VELOCITY** or **LENGTH**. VEL jack(s) will output a voltage corresponding to the note velocities, or note lengths.
- ▶ **MIDI OUT:** Panel MIDI Channel this TRAX will use. 1-16, none, or MPE Zone 1/2. (chan. 2-5)
- ▶ **LINK OUT:** Link MIDI Channel this TRAX will use. 1-16, none, or MPE Zone 1/2. (chan. 15-12)
- ▶ **GLOBAL REC:** Channel used to record into all TRAX trackers. 1-16 or All (default)
- ▶ **BRIDGE MAP SIZE and Bridge Map:**
Bridging is to connect Gates while CV changes. Turning on Bridge for a step will hold the gate on until the next note in that lane. The Bridge Map size can be 3 steps to 16 steps, which are shown as sequence progresses. The bridging sequence steps are turned on/off by selecting a step box and clicking it.
Note: Bridging steps has no affect on MIDI output (MIDI notes can't bridge), CV Mode jack source must be set to a TRAX output.

Adding a note

Double-click anywhere on the grid and scroll through the notes. If not playing, the note, then other notes in the step, will be auditioned as you select. Click to exit and set the note.

To transpose up/down all existing notes in a step, scroll into the Step# column then double-click, scroll.

Editing a note

An easy way to access basic settings for a note is to triple-click it. A menu will open with the following:

- ▶ NOTE:nn This is the MIDI note number i.e. C3=36
- ▶ VELOCITY:nn This sets the Note's velocity. Also called Note Level.
- ▶ DELAY:0:nn This sets the notes delay in 24th's of a beat at 2 ticks resolution (at 24PPQN)
- ▶ LENGTH:n:nn This sets the note's length in ticks. 0:24 is one full step. 8:00 is 8 steps long.
- ▶ FX SEL:n This selects a NoteFX bank to use for the note. 0 = none.
- ▶ FX:EDIT> This jumps to FX*EDIT if FX SEL is not 0. See Section V. B. for info on Note-FX
**Hold the encoder to exit, like any other menu or list*

The TRAX Pop-Out:

There are many ways to modify notes, or groups of notes, in the grid using the Pop-Out QB Buttons.

Scrolling to the right, past the 4th lane will open the pop-out window with editing controls, and enhancements to assist in building a sequence. These QB's are:

-- Sequence Arrangers--

- [COPY] Turn on to Copy area of the grid. Also creates a Recall (undo) backup ~
Once a Copy is executed, this switches to [PASTE] also hi-lighted. (See below)
- [SKIP:n] Set Fill to skip every 2nd, 3rd, 4th step hi-lighted. Works with all adjusters, Copy/Paste
- [FILL:nn] Selects number of steps to edit at once. Automatically on with Copy/Paste.
- [SHIFT+-] Shifts all lanes or a single lane (over Fill/Skip range or entire sequence) up/down ~
- [DELETE] Deletes notes from the grid. Can be used with [FILL:nn] and [SKIP:nn]. ~

-- Note Modifiers --

- [SCALE:xx] Applies selected Scale to notes hi-lighted on the grid with Lane 1 as the Root. Hold for Scale Settings ~
- [RANDOM:n] Applies Randomization amount to notes selected on the grid ~
- [DELAYER] Click to show/edit all Note's delays. Click again to hide Delay unless notes selected ~
- [LENGTH:] Click to show/edit all Note's lengths, click again to hide lengths unless notes are selected ~
- [LEVELS:] Click to show/edit all note's levels, click again to hide levels unless note selected. ~
- [FX * EDIT] Click to show/edit all note's NoteFX# 's. Hold to enter Note FX Settings (see [part c.](#) below) ~

-- Sequencer Settings-

- [-RECORD] Click to toggle on/off Record function for recording notes and Remote CC control. Hold for Settings.
- [X2 SIZE] Click to double the sequence size and duplicate lower half to upper half.
- [BOTT:nn] Sets the Start (bottom) Step of the Sequence.
- [SIZE:nn] Sets the Size of the Sequence.
- [SOLO+PL] Click to lock TRAX Play to this Sequence Letter. Click again to Solo this sequence
- [+PLIST+] Click to Add this sequence to the Playlist. 1 block added per click.
- [:SETUP:] Press and hold to enter Setup Menu for this TRAX Sequence Letter (see next page)
- [RECALL] Press to Recall sequence to entry state or last [COPY] state.
- [:EXIT:Let] Exit TRAX Editor. Holding encoder anywhere on the grid also exits.

(~) *Can be used with FILL and SKIP to select multiple / staggered groups of notes to quickly modify*

[SCALE:xx]

Scroll right through the grid into the QB pop-up and down to [SCALE:] to access editing of this unique TRAX#/Letter's User Scales:

- ▶ NOTE OFFSET:N Select note offset for this TRAX # (Also Modified by TRAX Remote CC Step Control)
- ▶ COPY FROM SONG FX: Copy All User Scales from Song FX:1-16
- ▶ SCALE EDIT:n Select a User Scale to edit
- [C][D][E] . . . Toggle keyboard notes to include in scale

Any single Note in any Step of a TRAX Sequence can have FX applied from one of 8 bundles in that tracker. This is a guide to NoteFX settings and what they do. Hold [TRAX:n] QB, then select a TRAX Letter (A) to enter the TRAX Editor. We'll add a few notes then apply various affects to one of them for clarity.

- 1) Double-click to place a few notes around the grid. ** If this is a new TRAX# or Letter then MIDI=Chan.01*
- 2) Press "P" button to play the new notes on the grid.
- 3) Triple-Click a note you would like to add some FX to, then scroll down to ►FX SEL:n
- 4) Click and scroll to change to FX SEL:1. Click to set then scroll to FX 1 EDIT► and click to enter FX EDIT
** [FX*EDIT] can also be accessed from grid by scrolling right into pop-up QB's to FX*EDIT and hold.*

NOTE FX TRAX:1 A .

- TRAX EDIT FX:1 Selects which NoteFX bundle to edit. 1 to 8
- COPY FROM T:1:A FX1 This is to copy from another TRAX # and Letter in the Song Project.
- RANDOMIZE: Select a modifier or FX to add randomness to:
 - NONE: No Random control
 - GLIDE:n Up to full +/- randomness to Glide Rate
 - CC#--/CC#-- Up to full +/- randomness to MIDI CC#-- value
 - MICRO ARP Adds randomness to Echo/Chop Micro-Arp Sequencer's start point
 - VELOCITY Randomizes Velocity of note by +/- 32
 - DELAYER: Randomizes Note Delay up to full range (22 ticks)
 - LENGTH: Randomizes Note Length up to +/- 8 ticks
 - CHOP/ECHO With Echo randomizes Feed, with Chop (ratchet) randomizes count
 - FINE TUNE: Sets Pitch Wheel up or down 1 semitone (100 cents)
 - MIDI PAN: Randomizes MIDI Panorama (left/right) for this step.
 - SOLO DUCK Solo's this TRAX Number over other TRAX for just this step. No affect on Song/Layers
 - BRIDGE Random placement of gate bridges (no affect on MIDI)
 - SKIP NOTES Randomizes Probability setting by up to 50%
 - REPEAT Repeats last step. Warning: may set sequence out of sync
- RAND RANGE:n Intensity of randomness 1 to 8
- ECHO:REPEAT:n Turns on Echo Mode, sets number of echoes of note. Chop turns this off.
- ECHO:FEED:nnn% Echo level to next echo, from 1% to 150%
- ECHO:TIME:n:nn Time echoes are spaced apart as Steps : Ticks (i.e. 2:12 is 2.5 Steps)
- CHOP:MULT:OFF Set Chop Multiplier (Ratchet) 1-8 repeats per step. Disables Echo Repeat.
- CHOP:CURVE:OFF Set curve of Chop timing -15 to +15.
- MICRO ARP=s +nn Echo/Chop Arp Offset Sequencer. "s" is starting step, "nn" is +/- notes offset
- MIDI PAN:+n MIDI Panorama for this Note/Step -64 left to +63 right, 0 is centered. (*)
- INSTRUMENT:nnn MIDI Program Change selects a different instrument (must be set back)
- FINE TUNE:+n MIDI Pitch Bend +/- semitone, CV semitone offset. (*)
- GLIDE:n Glide Start note. If 0 then uses last note on channel. CV Glide.
- GLIDE RATE:nnn Speed of Glide to next note. MIDI full range, CV matches MIDI width setting.
- CC#:nnn TO nnn Set 2 MIDI CC Values for this note/step only. (*)
- NOTE PROBABLTY:nnn The probability of this Note and it's FX occurring. 0 to 100%
- FX MAP SIZE:nn Sets the Size of the FX Mask Sequencer 3 to 16
- FX MAP STEP: /nn Sets step divider TRAX Steps / nn. nn=1 to 64.
- [1] [2] [3]...[15][16] Toggle FX MAP on/off. Hi-lighted step enables FX.

** MIDI MPE allows division of MIDI FX to single notes while non-MPE affects entire Step.*

Note FX Tips:

- Note probability only applies when step is not masked so FX can be applied, otherwise the note will play as usual.
- Instrument change is permanent for this TRAX Channel. Another NoteFX# can change it back if desired.
- Echo Repeat adjustment will reset Chop Mult, and vise-versa. Echo and Chop cannot play at the same time.
- MIDI Panorama only applies to the note(s) while in step, not any following Echoed notes.
- Fine Tune uses MIDI Pitch Bend and CV Semitone according to MIDI PUSH Pitch Bend Range setting. (ideal=+/-2)
- NoteFX Glide & Glide Rate are purely MIDI & up to synth. Use CV MODE to set a CV Jack's glide to match your synth.
- FX Mask Map is shown in main TRAX Editor grid, but updates on each sequencer cycle, if not /1 will show as all on/off
- Notes with a velocity of 1 will not play, but Note FX will -for automation-like control of CC's / PW / AT / PC on MIDI channel

2. Recording to a TRAX Sequence

II. C. 2.

The TRAX trackers are 4 lanes wide, so can accommodate up to 4 notes at once. When recorded into, notes will be quantized (unless set not to be) to the Tracker Steps. This quantizing depends on the rate of the steps. By default this is Clock * 2.

a. Record Settings

-In a [TRAX - n]→[TRAX EDIT] Quick-Box, scroll to -RECORD- then press & hold to enter the settings.

-Select options and scroll to change them:

- ▶ REC NOTES VEL?NO Do you want the velocity recorded or a fixed value of 100?
- ▶ REC NOTES LEN?23 Do you want note lengths as you play (YES), or a fixed value (1-23 ticks)
- ▶ REC NOTES DEL?NO (YES) This records delay into the step, thus "removes" quantizing
- ▶ KILL NOTE FX? NO New notes will erase "NoteFX" you may have set in the editor
- ▶ RE-NOTE MODE?NO Only record to existing sequence Notes, not creating new ones.
- ▶ GLOBAL REC=CHAN:n Sets which channel will record to this TRAX tracker (1-16, ALL)
- ▶ MIDI THRU CHAN:n Notes during record will be output on channel 1-16, TRX (TRAX chan.), or none

-GLOBAL TRAX REMOTES-

These are powerful control notes that can change the way TRAX records while held down.

- Tapping the note twice will latch it on, and turn off any others.
- A single touch on the note will then turn the modifier back off.

These settings, while selected, can learn from a MIDI note input, or can be set manually.

** I like to use the top-most 3 white keys on my keyboard (A, B, C), then the black key (Bb) for the last remote key (Recall) for example.*

Here's what each does:

- DELETE NOTE:nnn** TRAX Steps will be deleted while this is held, or toggled on (2 taps!) Any notes played while erasing will cancel delete briefly so previous sequence can "poke through". Notes played just before tapping the DELETE note to release it will remain.
- STACK NOTE:nnn** This remote note turns on Lane Stacking. So any notes played will fill lanes after notes already in the sequence, which is great for building onto a running sequence.
- CYCLE NOTE:nnn** This remote note, when on, plugs notes in as stepping through lanes, creating new notes or overwriting previous ones while in present Step. This can be used to morph one sequence into another.
- RECALL NOTE:nnn** This will recall the sequence to it's previous state before recording, or to the state it was when double-tapped last, so single tap it to recall.

I recommend setting these remote notes as they greatly enhance playing around with a TRAX sequence. They only need to be set once for this Song, but can be truly globally set by editing default Song:00 and doing a special save (it's protected).

See [Section VI. E. 1. SAVE:INIT](#) * *These settings can also be accessed from within the TRAX Editor under the [RECORD] button!*

b. Direct Recording/Overdubbing

As notes are played in, they are placed onto the tracker Grid, and, depending on record settings above, will overwrite previous steps. Steps with more than one note can be overwritten with a single note. Step's lanes are stacked with notes played during that Step's duration, from Lane 1 to Lane 4... So if a note is held, then others played, each step will accumulate notes. This can also be achieved (and more) by setting up Global TRAX Remotes & Settings (below)

Note that if main [LOOP:OFF], and you have several different TRAX Letter blocks in sequence in the Play List, Record can carry over from one to the next. None are protected. If any block(s) loop more than once, then notes recorded will refresh the loop live while that block loops.

c. Legacy Sequencer Control Method

II. C. 2. c.

A.K.A. -TRAX REMOTE CC STEP CONTROL-

In addition to being able to record notes into the TRAX grid, steps can be modified remotely using MIDI CC's on the TRAX remote MIDI Channel(s), in a similar way to a normal sequencer module.



MIDI CC#'s to match your MIDI controller can be set in the TRAX Record Menu:

FUNC SELECT CC#: Selects one of 8 functions for the row of CC's to control
NOTE OFFSET CC#: This adjusts the Root note (if using a Scale Quantization)
CC# ROW START: The first CC# alignment for the first Step

** These settings when hi-lighted will MIDI learn, just move the control!
* Note that RECORD must be on, and the Sequence must be playing.*

The size of the row of CC's depends on the size of the sequence, 8, 16, etc. In this example, the CC# to control Step 1 is 11. This means Step 2 will be 12, Step 3 will be 13 etc.

The function the row of CC's will control can be selected with CC#43, which are:

RE-NOTE: Changes the Pitch of Step (Works with Scale!)	NOTE_FX: Select NoteFX# 1-8 for Step
VELOCITY: Adjusts the Velocity of a Step (All lanes)	FX_MAP: Turn on/off FX Mask Steps
LENGTH: Adjusts the Note-Lengths of a Step (to >5 steps)	KILL: Removes a step or recalls it
DELAY: Adjusts the delay of a Step (0 to 22 ticks)	SHIFT: Shifts Lane 1-4 up/down

** These Changes are permanent and can change ANY TRAX Letter that is playing, so turn on [SOLO+PL], or main [LOOP:ON] if you don't want this. The editing TRAX can still [RECALL] as above.
* See [This YouTube Video](#) for a better explanation and demo of this cool feature*

3. Applying TRAX FX (Button Global Dropdown)

The TRAX QB drop-down has some easy to access per-quick-box settings when clicked:

[TRX SOLO]	To solo all sequences within this TRAX QB
[TRX MUTE]	To mute all sequences within this TRAX QB
[LEVELS:--]	To set overall velocity limit for this TRAX QB
[SWING+/-nn]	To set a swing for this TRAX QB. (Has menu, see below)
[MIRROR:nn]	Set a Note Mirror point for all sequences in this TRAX QB (*Has settings, c. Mirror... below)
[SCALE:xx]	Select a scale Maj/min/Maj7/min +4 user set scales (hold to enter scale settings)
[LIMIT:>/<nnn]	Set maximum or minimum note for all sequences in this TRAX QB
[TRANS:+0]	Set Transpose for this TRAX QB +/- 48 (adds to master and songFX if applied)
[-RECORD-]	Turn on/off TRAX record mode for all sequences in this TRAX QB
[TRX ERASE]	Clear presently playing sequence in this TRAX QB (Only if TRAX QB is not the last)
[:DELETE:]	(Only in last TRAX QB) "Removes" this TRAX QB and deletes all of it's blocks in Play List (recover with [TRAX:ADD])
[:EXIT:]	Exit TRAX QB Drop-down. *Can be exited from TRAX:EDIT at top too!

a. Levels (Velocity)

The Levels setting places a limit on velocity when not "--". Set from 1 to 99.

b. TRAX Swing + Swing Mask

The TRAX Swing can reverse swing (on negative side) with a range from -99% to +99%. The is far beyond the usual 50% and will offset the main (SongFX) Swing if active. Under the [SWING+/-nn] QB is a Swing Mask Sequencer, exclusive to TRAX. Hold QB to open the settings for Size of the Mask Sequencer, 2 - 16, and up to 16 blocks to turn on / off swing steps. The clock for this sequencer is the same as this TRAX Button's Clock.

c. Mirror (Notes)

Sets a point at which notes are "reflected" upward and downward as an FX to change the way TRAX sequences sound. Mirror is situated before [SCALE:xx] in the chain, which can then be transposed by [TRANS:+0] for full flexibility. Under the [MIRROR:nn] QB is a small menu to set whether the QB parameter steps in octaves (6 semis x 2 =12!), and low and high limits beyond which notes will not be mirrored. The latter is to stop extremely high or low "reflected" notes letting them pass unaffected, although the [LIMIT:><nn] QB can stop notes that are too high or too low.

d. Scales + Settings

Each TRAX QB has it's own [SCALE:xx] QB, with 4 presets (Maj, min, Maj7, min7) and 4 User scales. All TRAX QB's share the same user scales.

- Under this QB the 4 user scales can be set by turning on/off keys (as with SongFX Scales).
- Alternatively, a User Scale from presently playing SongFX# can be imported by using **COPY FROM SONG FX:Y** (no undo!)
- The Transpose control in this menu will also change this TRAX QB's [TRANS:+0] setting.
- All Scale changes are immediate and if not Playing, the changes will play out as an audition on the TRAX's MIDI Channel.

e. Limit (Notes)

The Limit stops notes greater or less than the setting by wrapping them 1 octave. Notes are not lost, just limited by adding or subtracting octaves. Scrolling down (arrow left) will set an upper limit, or scrolling up (arrow right) will set a lower limit.

f. Transpose

Each TRAX QB Button has it's own Transpose. This will offset the Master Transpose QB, which may be offset by a SongFX#'s Transpose as well (if it's Transpose is applied to TRAX). Like all other Transpose QB's the range is +/-48 semitones.

D. Automation Recorder

II. D.

The Automation Recorder is an extra MIDI recorder to add MIDI Control Changes, Pitch Bends, or other controls to a channels thus modifying the way it plays. The advantage is that this can be inserted in one place but not another, or change a looping sequence slowly over many bars. (Up to 999).

An automation, recorded live, can be any MIDI channel including the Remote Channel. Any automation playing on the same channel as designated Remote channel will be used to modify parameters created by the Remote Learn method, following the Song:nn and Global rules in [REMOTE:nn]

While this is probably not as good a method for parameter control as PLFX, it can be useful for more frequent changes as is not quantized to bars but in real clock time.

In addition the MIDI output can be captured and presented to a CC output jack by selecting MIDI CC as it's function along with the CC#, and even using the smoothing feature in [CV MODE:n]. This can in turn be used to CV control your modular filters, levels, mixes, etc. much in the way an envelope output would, but much longer.

1. Recording an Automation

To record an Automation,

- select the [AUTO-REC] QB and scroll to [-RECORD-] and click.
- Scroll to set bar count you want to record for. 1-64 or scroll left to "ST" which means you must hit the "S" button to end.
- Click to arm. The QB will change to [AUTO ARM]. ** To cancel, click again, scroll to [-RECORD-*] and click to cancel.

a. To Send MIDI CC/AT/PW

- If Playing Sequences ("P" LED on), start sending your MIDI CC/PW/AT/PC at the appropriate times
- If not Playing, AutoRec will still record as long as there's a clock signal, so send your MIDI when ready!

The QB will change to indicate bars remaining re: **A BARS:nn** . If bars was set to "ST", then will count upward until "S" is hit.

b. To Change Remote Parameter

Any Automation that is on the set Remote Channel will control the parameters just as if you were adjusting it remotely in that moment. MIDI notes on the remote channel will be recognized and sent as well. Other channels recorded at the same time will still be sent through to MIDI/LINK outputs. If the remote channel is changed, then the MIDI messages will be output as normal.

Simply set your controller to the Remote channel and adjust the parameter(s) you have previously "learned" into Remote Song:nn or Global map to the starting points before hitting Automation Record.

***These values will not return after the Automation ends so if that's important, remember to return it before the recording ends.*

2. Play List [AU] Track

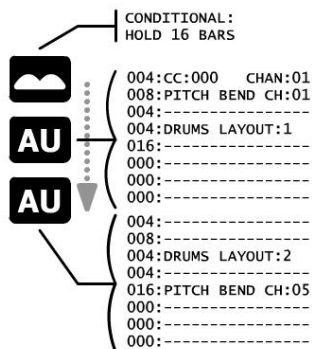

Automations can be played from the [AU] track in the Play List (extreme right side of grid) in the same way as all other tracks. When an automation is recorded, if the Block doesn't already exist it is created as an isolated block.

As each row in the Play List defines a different combination of automations, the only visible parameter is [AU]. When moused over, the total bars the block will use is displayed.

Double-click the grid to place a block with [ADD NEW] or to edit which automations to use with [--EDIT-->].

To the left is the original bar count of each recording, followed by the name of automation to add clarity. The diagram to left demonstrates how one block can have different automations enabled. Click on one to enable/disable it.

The block will use the maximum bar count in use, but this can be trimmed by setting **MAXIMUM BARS:nnn** from 1 to 999. Setting higher values can also delay execution of the following Block if desired.

**PLFX* can also be added to blocks in the automation track.*

3. Overwriting an Automation

Automations are normally recorded to an empty slot until full at which point the last will just be over written.

To overwrite an existing Automation, click the [AUTO-REC] QB then scroll to [AUTO :--] and select. Scroll to set the automation number (1-8) you wish to record to / over next. Continue with record procedure as above.

New! Deleting an Automation

An Automation can be deleted by selecting and automation # with [AUTO :--] then scrolling to [DELETE]. The automation will no longer appear in the PL Automation list, and automatic record selection will once again include the deleted Automation #.

III. CV Mode Settings (MIDI → CV)

The [CV MODE:n] QB will select up to 4 different CV/CC Jack configurations or up to 8 [DRUMS:n] layouts, immediately. Under this QB you can make settings for each jack / row to select a MIDI source, channel, jack glide options, and velocity & envelope options for the CC jacks. There is also a CV MODE:n selector to switch from one to another while in the settings.

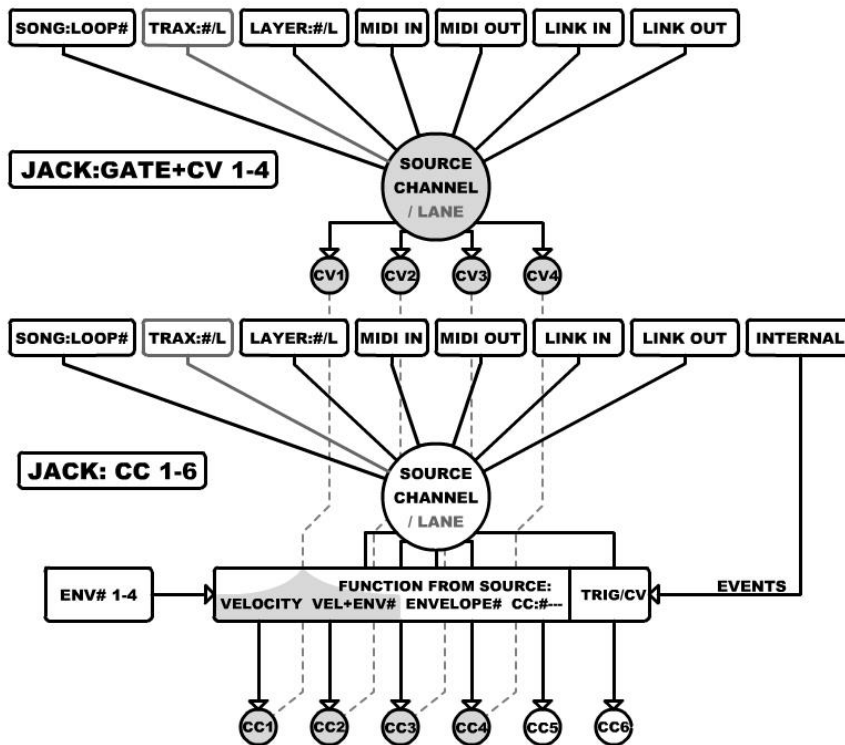

As depicted in the diagram, CV Jacks and CC Jacks are quite different. CV jacks are 1V/Octave and tunable via auto-calibrate, while the CC Jacks are generic -5V to +5V outputs.

CC1 to CC4 Jacks can output MIDI Note velocities from it's row, or output an envelope triggered by any source or a velocity attenuated envelope. These jacks can also output useful triggers from internal events such as beats or bars, TRAX sequencer resets, Song Loops, or Play/Stop or Solo states. Beat Steps can step voltage for some basic external control to other modules.

In addition to CV Mode set assignments, CC1 to CC6 Jacks can be driven directly by the envelope generators, so can be shared by two sources.

CC5, CC6, and CLKout jacks can be set to be inputs to Play MIDI notes, send MIDI CC, PW, or channel after touch messages, start/stop play & reset, or control nearly any parameter.

Each Jack can have a defined single source, like Song Loop#5 or TRAX#2B, or tap into a MIDI Out channel no matter the source, including MIDI or LINK inputs. Hold the [CV MODE:n] QB to enter the Settings. The following section describes all of the settings available for the Jacks, including Drums mode.

A. Gate + CV Jacks

Clicking on →JACK:GATE+CV 1 -- selects which gate+CV row you wish to set up. Continuing past these 4 will select a CC Jack which is covered in the next section. The list of settings below will change once a jack is selected.

1. MIDI Sources

- ▶ **SOURCE:xxx** Select a MIDI source for the Jack from the following inputs:
 - NONE** No Source
 - SONG:LOOPn** A specific Song Loop# or "ALL" Song Loops will send to this jack(s)
 - TRAX:n L** Trax #1-5 with TRAX Letter or "ALL" letters will send to this jack(s)
 - LAYER:n L** Layer #1-4 with Layer Letter or "ALL" letters will send to this jack(s)
 - MIDI IN** Panel MIDI IN on set MIDI channel(s) will send to this jack(s)
 - LINK IN** Backplane LINK input on set channel(s) will send to this Jack(s)
 - MIDI OUT** All Panel MIDI Output on set channel(s) will send to this jack
 - LINK OUT** All Backplane LINK Output on set channel(s) will send to this jack
- ▶ **MIDI CH:nn** For Song/Layer/MIDI & LINK I/O source, this sets the Channel 1-16 or "ALL"
- ▶ **LANE:#:n** For TRAX Source, this sets which TRAX Tracker Lane (1-4) will send to this jack
-- OR --
- ▶ **MAXIMUM OCTAVES:ALL** Set to limit octave range to 3, 4, or 5 octaves only. "All" will cover up to 10 octaves.

- ▶ **FUNC: NOTES** Placeholder: This parameter is locked while setting a CV jack. The 4 CV jacks can only be notes.

2. VCO Selection

III. A. 2.

- ▶ **ROW:n vvv** Select a VCO Tuning name (vvv) for this row (n) of this jack. (GATE+CV jacks only)
- ▶ **TRIGGER:NO** Selects trigger mode so Gate lengths won't matter. This uses drum trigger time setting (in mS)

3. Glide Options

- ▶ **GLIDE TYPE:xxx** Turn on and select Glide type for this jack. Up/Down, Up, Down, or Glissando Up or Down etc.
**Note: Glissando is more noticeable with longer glides. ** CV Glide has no affect on MIDI glide.*
- ▶ **GLIDE:RATE:nnn** Set the speed of the glide between one note and another from 1 to 127. 0 is off.
- ▶ **GLIDE FROM NOTE:** Set a starting note for the Glide from 1 to 127. "---" defeats starting note function
- ▶ **GLIDE:VELOCITY:** If "YES", the velocity of triggering note will act as Glide Rate attenuator in %. Thus Velocity >100 gains Rate.

4. Merging MIDI / LINK Inputs & Copy

To directly output notes to CV from panel MIDI input, or LINK MIDI input, turn on as required. Keep in mind that if for example **MERGE MIDI IN = YES** and the jack's source is MIDI OUT, two triggers will be sent which may cause CV jack Order Modes such as **ORD:CYCLE** to count two occurrences. As The Merges are the only way to directly output MIDI incoming, simply ensure that the jack's source is not MIDI/LINK Out.

**Note: Source MIDI Channel must be set here to match your keyboard or controller channel (or set to "All") or it won't work.*

▶ **COPY FROM:xxx**

Copy from another CV Mode will copy entire CV Mode#. Copy:Song n will fill from same CV Mode# in selected Song Project.

B. CC Jacks (Output)

III. B.

Scrolling to →**JACK: CC 1 - 6** -- will select a CC Jack to configure. These jacks are for Velocity, MIDI CC, or envelope outputs. As CC5 and CC6 jacks are bidirectional, these must be set as outputs in **[MIDI PUSH]** QB to be configurable here.

* See [Section V. D. CV Remotes](#) for more on using CC5 & CC6 as inputs.

1. **MIDI Sources** (The Velocities of Source Notes will be sent to this jack, by default. See 2. CC Function below)

▶ SOURCE:xxx	Select a MIDI source for the Jack from the following inputs:
NONE	No Source
SONG:LOOPn	A specific Song Loop# or "ALL" Song Loops will send to this jack(s)
TRAX:n L	TRAX #1-5 with TRAX Letter or "ALL" letters will send to this jack(s)
LAYER:n L	Layer #1-4 with Layer Letter or "ALL" letters will send to this jack(s)
MIDI IN	Panel MIDI IN on set MIDI channel(s) will send to this jack(s)
LINK IN	Backplane LINK input on set channel(s) will send to this Jack(s)
MIDI OUT	All Panel MIDI Output on set channel(s) will send to this jack
LINK OUT	All Backplane LINK Output on set channel(s) will send to this jack

▶ **MIDI CH:nn** For Song/Layer/MIDI & LINK I/O source, this sets the Channel 1-16 or "ALL"

▶ **LANE#:n** For TRAX Source, this sets which TRAX Tracker Lane (1-4) will send to this jack

-- OR --

▶ **V-RANGE** Sets Envelope Voltage Range from 25% to 100% (default)

2. **CC CV Function**

FUNC: If set away from **NONE**, any CC Jack can function as an output from the following sources:

a. **Velocity**

The Velocities of source Notes will be output from this jack. The level remains after the note is finished (latching)

b. **Velocity + Envelope**

The Velocities of source Notes will act as gain parameter for the Envelope number selected to be output on this jack. The envelope is triggered by the MIDI source selected above.

c. **Envelope**

The selected Envelope will be output on this jack as triggered by the MIDI source selected above.

d. **MIDI CC to CV**

Select this Function to output from a MIDI CC originating from the MIDI source selected above. Once selected, scroll to the CC# 0-127 you wish to use. Use MIDI CC Smoothing options if desired (below)

e. **Trigger Outputs**

FUNC: TR: SONG LOOP

Select then scroll to select a source to output a trigger pulse on this jack. The choices are Song Loop, Bars, Bars + Beats, TRAX 1-5 Sequence Resets, Play State, Solo (any)

f. **CV: Transpose & Beat Step Outputs**

FUNC: CV: TRANSPOSE

Select then scroll to select a source to output a CV from to be output on this jack. Transpose is output as +/- 1V/Oct while Automation CV's (1-4) are set as +/- Voltage (approx.) from within an automation list.

CV: BARS+BEAT function will step 1 volt for each beat (0 - 1 - 2 - 3 volts) continuously with clock rate.

3. **MIDI CC & Envelope Options**

There are some additional settings for the final stage before CV output to a CC jack:

▶ BI-POLAR: YES	Set to " NO " will prevent negative voltages from appearing on the jack.
▶ MIDI CC SMOOTH: NO	" YES " will turn on CC2CV smoothing as the CC CV output is much finer than a MIDI CC.
▶ SMOOTH STEP: n	Set the smoothness of the CC from very quick to ultra smooth (good for filters)
▶ ENV GATE HOLD: NO	Turn this on to gate the envelope so holds or freezes when gate ends.
▶ ENV RESET: NO	Turn this on to reset envelope with each gate rather than playing through & restarting on next gate
▶ ENV RATE X1:	Envelope speed X1-X8. This does not improve resolution (Use Envelope Settings for that)

4. **Merging MIDI / LINK Inputs & Copy**

To directly output MIDI (CC's) to CC CV from panel MIDI input, or LINK MIDI input, turn on as required.

*Note: Source MIDI Channel must be set here to match your controller's channel (or set to "All") or it won't work.

The [CV MODE:n] QB can be set to [DRUMS: n] . This will switch the 12 Row jacks to be trigger jacks for up to 12 drums. This can also simply be used as a trigger sequencer as long as the source sequence is on the percussion channel (default = 10). There can be up to 8 Drum configurations, each with it's own set of 12 assigned drums to bring to the panel. These can be set by simply scrolling to the top on the main page, then continue to scroll into the drum pads. Click to edit. The drums default to descending order but can be re-configured in any way you like. The other way is to edit from the list under the selected [DRUMS: n] QB.

Drums settings are global so will apply to any Song Project. This assumes you keep the same type of patch from project to project. The drum # can be different though. Logically you should use the same jacks for the same types of drums but an alternate map might be useful if, for example, the kick in one project is 35, while in another is 36. If you only have one Kick, then the same jack can always be used for Kick.

If set back to a CV Mode, all projects will use CV Mode, but may use different CV Mode #. Under the [DRUM:n] QB there are drum related settings. These are as follows:

1. MIDI Sources

Select **SOURCE:** of drum triggers from Song, Layer, TRAX, MIDI in, LINK in, MIDI out, or LINK out. For universal use, MIDI out is the best option (default), but if you only want TRAX or Layer drums to trigger modular drums, then select that. Set to MIDI in or LINK in for a MIDI note to trigger anything application. Setting source to "none" could be used as an indication that modular drums are not to be used with a certain project.

If you want to use a Song / TRAX /Layer source but also want input drums to trigger, then turn on the corresponding **MERGE**.

2. Drums Channel

This will generally be set to Channel 10, but can be changed. This is the master percussion channel used throughout the Song Project to avoid transposition or SongFX sub-sequencer Re-trigger blocking etc. so keep that in mind before changing.

3. Drum Layouts

The 12 "notes" of drums can be modified here (as well as from the main screen) More than one jack can send the same drum's trigger, if you're short on mult's!

Simply click the one you want to edit, then click to save. Other Layouts can be edited while in this menu. As mentioned above, drums can be changed from the main screen when in Drum mode. Because they flash while playing, this may be the better option if you are not certain which drum is what. The name of the drum appears on the screen near the block, as well as in the list of drums/jacks when in menu.

4. Trigger Time

The trigger size can be set from 10mS to 200mS. For some applications, a shorter trigger time may be preferable. Most drum modules like a short trigger time. If using the jacks for a MIDI note to Trigger conversion, it may be preferable to set the Trigger to **GATE**, thus the gate's "on time" relies on the note's on time.

D. Order Button (Chords)

III. D.

The [ORD:xxxx] QB has methods to handle distribution of simultaneous notes from the same source when CV Mode has multiple jacks assigned to them. They can also be from different sources or channels. Each type has settings under it.

1. Stacked Notes→CV Jacks (Chords) + Settings

For single source of notes as chords, Stack order is probably the best. Hold [ORD:STACK] to go into it's settings to make changes that may enhance the way notes are played onto the jacks. Here's a list of Stack behaviors:

- Stacking will consecutively place notes onto the next higher non-used CV
- If a note is released, it's place in the stack is preserved if played again before another note, even if the rest are released.
- If Stack Settings **RELEASE:TIME** then stack positions can be held for the set time (in Beats:Ticks)
- Overload Notes can be muted, played by the last CV jack, or roll to the first.

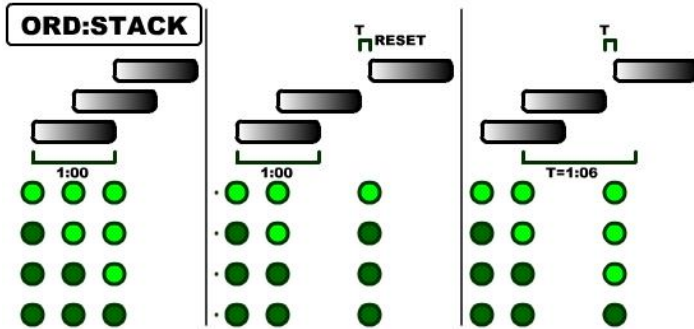

The diagrams left show the 4 green LED's states with each note added. The first is the default behavior.

The second diagram shows a Release Time setting but it's too short to prevent the stack from resetting.

The third diagram has a longer release time so it will "hold" the stack from resetting to the beginning from a release of the first two notes, even though they are no longer down.

* Note: Time settings will use last known clock.

2. Ranged Notes→CV Jacks (Splits) + Settings

[ORD:RANGE] is different than all of the other Order Methods in that it simply mixes multiple channels and sources, up to 4, to split into ranges. This is useful for dividing VCO's by bass/treble/ high response. Holding the [ORD:RANGE] QB allows the setting of the ranges.

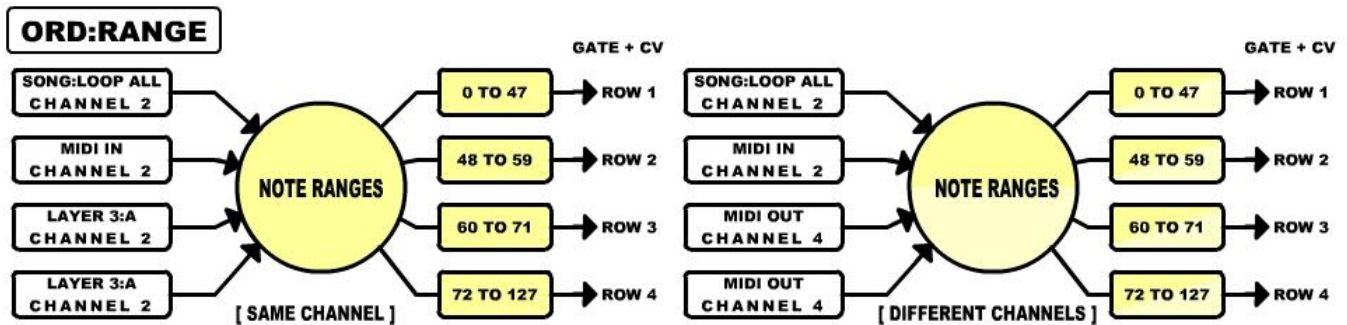

3. Cycled Notes→CV Jacks (Chords+) + Settings

The Cycle Order method relies heavily on timing, but can still be used with live playing. To become familiar with the method, it's advisable to play a sequence in TRAX or record a loop in Layers to play over & over. The main Cycle behaviors are:

- Notes must be played within Minimum Time and Release Time or they will not stack or cycle.
- A new note played while last note still down will play on the previous CV row if less than Release Time.
- Notes can address CV's upwards, downwards, or Alternating directions.

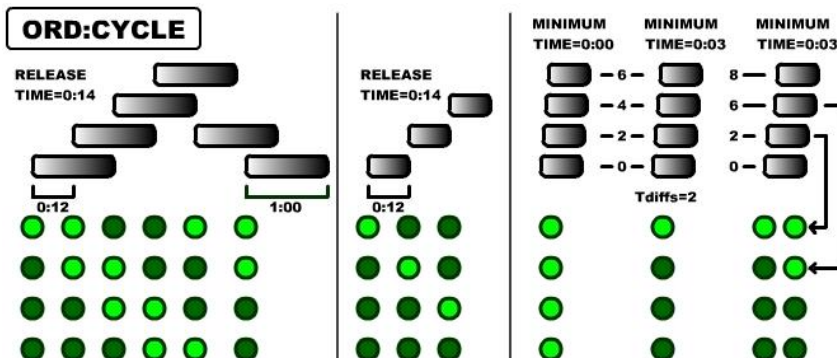

Release Time and Minimum Time place a sort of speed-limit on incoming note cycles. Faster notes can pause the cycle, medium speed notes, step through, but slower notes reset and stall the cycle.

The diagrams show the gate LED's vertically as with the Stack method.

Downward & Up/Down directions still start at the top CV row.
2 Channels can be used to split 2+2 or 3+1.

4. Random Probability Notes → CV Jacks + Settings

III. D. 4.

This sorting method acts like a pinball machine where balls (notes) fall through probability points (the jacks).

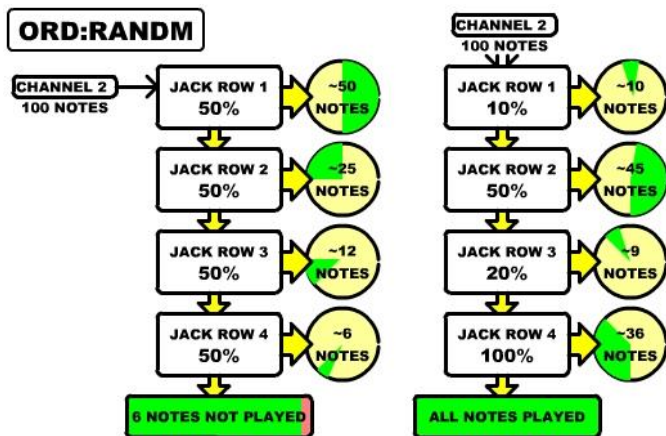

Each point can be set by holding **[ORD:RANDM]** to adjust each jack's likelihood of outputting a note. The Range is 1% to 100%.

Care must be taken if you want to avoid skipping notes as shown in first diagram. Ending the involved jacks with a 100% will catch any that managed to get through.

Contrarily, if the upper jacks have too high a percentage then it will be far less often the jacks below it will output a note.

Another way to use Random Order is to assign specific channels to pairs of jacks or single jacks (in which case the random percentage becomes a pure probability whether notes sound on CV or not)

5. Arpeggio Notes → CV + Settings

The 5th Order Mode is **[ORD:ARPEG]**. This can be up to 4 Arpeggiators, one for each Gate & CV jack, each with it's own Mask Sequencer, clock multiplier, Size setting, type, quantization, and latch option. If Arp is turned off for a jack, notes on the assigned CV channel will simply present as normal Gate & CV outputs. In CV Mode, any channel can be assigned to a jack, and even to more than one jack to provide multi-timbral arp's from one source.

Arp can be used while Playing or Stopped, with any source set in **[CV Mode:n]** QB. Arp does not send to MIDI outputs, but sends the original MIDI if not blocked.

To enter the settings for each jack, scroll to, then hold on **[ORD:ARPEG]**. The Arp menu is as follows:

- ▶ **→JACK:GATE+CV n** Where "n" is jack Row 1-4. Use this to select which row to edit
- ▶ **CV ARPEG: YES** Set to **NO** to bypass Arp and just play single notes on this jack Row
- ▶ **MIDI ARPEG: NO** Set to **YES** to also send Arps to MIDI along with original. Some mono-synths may not like this.
- ▶ **LATCHING: NO** Set to **YES** to enable note latching. Arp will continue even when keys released.
- ▶ **STEP TIME: 1/8** Set Arp time to 1/4 (clock), 1/8, 1/12, 1/16, 1/24, 1/32
- ▶ **GATE LENGTH: 50%** This sets relative gate length per Arp note from 1% to 200%
- ▶ **QUANT: NO** Set to **YES** to align Arp Steps to clock. If **NO**, then will begin and align from first note received.
- ▶ **OCTAVE+1:NO** Set to **YES** to add an octave sequence to this Arp (i.e. C3,E3,G3 then C4,E4,G4)
- ▶ **NOTE HOLD:YES** Set to **NO** to allow Mask to skip over notes on, or **YES** to play all notes in succession
- ▶ **RESET:NO** Set to **YES** to allow first note on to reset the Mask sequencer pointer. Free runs if **NO**
- ▶ **TYPE:UPWARD** Select an Arp Type: Up, Down, Up/Down, Up/Down2, Skip1, Skip2, and Random.
- ▶ **MIDI VELOCITY:NO** Set to **YES** to allow captured note velocities to be sent to MIDI (Vel Jack uses source note's Vel)
- ▶ **SIZE: 16** Set number of steps for the Arp Mask from 1 to 16 steps (default is 8)
- [01] [02] [03] . . .** Scroll over boxes and click to toggle on/off steps. They are all on by default.

Arp Info:

- * If the Gate Length is >99% then the following step will not trigger a Gate, but will still CV to the new note. If **MIDI ARPEG** is on, then the same will occur but the following note won't be played. If set to 200%, then a 3rd step's Gate won't trigger.
- * **NOTE HOLD**, when on, prevents notes from being skipped by Masked steps.
- * **QUANT** is more desirable for external MIDI / CV input notes, may cause delay with already quantized notes (Song / Layers)

CV Mode # vs. Order Modes & Settings:

Each CV Mode (1-4) can have it's own order method to match with all of the jack settings etc. Each Order method's settings are also unique to the present CV Mode,

i.e. if **ORD:RANDM** on Row 2 is set to 35% in CV Mode #1, it can still be at the default 50% in CV Mode #2.

This makes each CV Mode # unique in every way possible.

Contrarily, there are only 4 Arp's and they are the same ones regardless of the CV Mode #.

Other CV Mode #'s (1-4) can be set to a different **ORD:xxx** QB, but CV Mode → Drums will disable the **ORD:xxx** QB as it's not applicable for drums mode.

IV. The Play List

A. Description of the Play List:

The Playlist is similar to a step tracker, but each track can step at a different rate depending on how long each step takes. The 11 x 64 grid is to place Blocks that represent different patterns, sub-sequencers, Song Loops, or automation lists. As each track is unique in it's placement, blocks cannot be changed from one track to another (except by importing TRAX from song projects!). There are 4 types of tracks in the Play List:

- | | |
|---------------------------|---|
| 1) Song Loops | Up to 17 Song loops can be placed / re-used in any order |
| 2) Layer Sub-Sequences | Up to 4 Layer Sub-sequencers per track can be placed / re-used in any order |
| 3) TRAX Tracker Sequences | Up to 8 TRAX patterns per track can be placed / re-used in any order |
| 4) Automation Blocks | Up to 4 Automation Blocks can be placed / re-used in any order |

This makes up to 65 unique Blocks to choose from to add into the Play List, + conditional blocks.

The Rules of the Play List are:

- Navigation: * Click to toggle horizontal / vertical scrolling
* Double-Click to open pop-up to apply an action to block(s), turn on/off functions, edit, etc.
- Arming Blocks: Any Block can be armed to Play at any time. Armed will play once presently playing block finished.
- Arming Rows: Rows of blocks can be armed from the Step # (far-left) column
- Playing Blocks: Armed Blocks will have flashing brackets, while Playing block's brackets will be on solid.
- Disarming: Any Block not playing (still armed) can be disarmed the same way.
- Group Loop: Any vertical sequence of blocks will fall to next until empty cell at which point will loop back to top. These unbroken chains of blocks are called groups. They can be placed anywhere in the Play List.
- Stop Playing: A Conditional Block can be inserted to stop/pause/wait a trigger. This can be at end or inside a group.
- Stop All: Pressing the Stop button will stop play, and re-arm all blocks previously armed.
- View Block: When cursor pauses on any block, "P#" (PLFX#) then Bars in the block will display (01-99, C+ if >99)

Entering the Play List Editor:

Scroll to [PLAY LIST] QB, hold to open Play List Editor.

Navigation:

Click to alternate scrolling between horizontal and vertical to select a cell in the grid.

The Header at the top of the Play List (always visible) indicates the track's designation:

SO | L1 | L2 | L3 | L4 | T1 | T2 | T3 | T4 | T5 | AU
Song Loops[^] ^ - Layer1-4 tracks - ^ -TRAX1-5 tracks - ^ Automations track

B. The Play List Pop-Up Buttons:

Double-click to open the pop-up Action window. Scroll up/down to select an action to apply to the selected cell you double-clicked on. These Actions are:

1. [:: ARM ::]

Click to "arm for play" the selected cell if exists, or the next block below your selection. Pop-up window will close. If the Play List Step # (far left column) was double-clicked, then will arm entire row.

* Blocks armed while Playing will not be recalled after STOP, but those armed before hitting PLAY will be recalled. This is so the Play List starts the intended way when the "P" button is pressed.

2. [+ADD NEW+]

This will either add a new block to the cell double-clicked upon, or allow editing of the cell's present block. Clicking on [+ADD NEW+] will close pop-up window, but allow adjustment of the selected block as follows:

- | | |
|---------------|---|
| Song track: | Add/Change Song Loop # from SS→01→16 |
| Layer tracks: | Add/Change Layer Sequence #, or create new Layer Sequence # from 1 - 4 |
| TRAX tracks: | Add/Change a TRAX tracker Letter, or Load a TRAX Letter from other song project (see below) |
| Auto track: | Add/Change an automation # 1 - 4 |

Each movement of the encoder will arm the block for audition if Playing at the time. Once the selection has been made, click to save.

Adding / Importing TRAX Letters:

A new TRAX Letter can be created by scrolling to beyond the highest letter. The mini-trax window will show "ADD:". This is good for recording, or the TRAX Editor can be accessed from the pop-up with [--EDIT→]

If scrolled beyond the "ADD:" window, all TRAX from all Song Projects will follow. If playing, each change will arm the block to play once a previous block is finished for auditioning. Depending on the size, midi channel, or clock rate, this could de-sync your steps in the Play List. If you are *performing* at the time, avoid live importing!

To Import to a new / different TRAX Letter, select or add it first (using [+ADD NEW+]) then select it again to import. Remember all the blocks in this track with this Letter will be using the imported sequence. To Revert to original saved TRAX just import from this Song Project. The mini-trax display will change to show your TRAX Letter name.

3. [+ADD COND]

This allows adding of a "Conditional Block". This type of block sets a condition to execute an action within the Playlist, like jump to, wait x bars, wait for song loop etc. It can also be used as a track stop, especially in a new group that may not include a certain track to be playing.

Double-click on an empty cell in the track you need to add it to, usually following a block. Scroll to [+ADD COND] in the pop-up window and click. This will open a list of options for this conditional.

The conditional # can be new, or can be scrolled through to re-use another condition defined before by editing **CONDITION:nn** Conditional blocks can be edited by using [+ADD COND] or [--EDIT→] in pop-up.

CONDITION BLOCK

- ▶ **CONDITION # 1** Select a condition for this track 1-8
- ▶ **HOLD BARS: - -** How many bars this block will wait before proceeding to the next block "--", 1-64, or CN (continuous)
- ▶ **HOLD UNTIL: - -** Select a trigger to release the "wait" and proceed or JumpTo. "--" is the default. (see below)
- ▶ **AND UNTIL: - -** Select an optional second trigger. This and the first "Hold Until" must be satisfied before proceeding.
- ▶ **JUMPTO:ROW:** Set a Play List row, 0-63, to jump to if Hold Until's are met. * If all others are"- -" then will jump now.
- ▶ **EXIT** Exit back to Play List. The cursor will still be on this Conditional Block in Play List grid.

Types of "HOLD UNTIL's":

- "--" Will only count the set number of HOLD BARS before proceeding if both Hold Until's are "--" (null)
- RESET Will effectively stop play. Can be re-started with main or MIDI Play, Clock re-sync, or RS input.
- CC5 INPUT Inputting low to high (>2.5V) on CC5 jack will trigger an exit from the block.
- CC6 INPUT Inputting low to high (>2.5V) on CC6 jack will trigger an exit from the block.
- CKO INPUT Inputting low to high (>2.5V) on Clock Out jack will trigger an exit from this block (when input)
- TRAX:1-5 A progression of selected TRAX in the Play List will trigger an exit from this block.
- LAYER:1-4 A progression of selected Layer *block* in the Play List will trigger an exit from this block.
- M:REMOTE A MIDI Remote (learned with this Cond#/Track selected) will trigger an exit from this block
- SONG:0-16 The Specified Song Loop# will trigger an exit from this block.

**Tip: Once in menu, you can edit multiple Conditional Blocks you may want to use on the track.*

A Conditional Block with no parameters set will act as a filler only, i.e. playing will skip over it, but if is alone and is jumped to from elsewhere in the Play List, will not stop the playing track (i.e. last TRAX letter will continue playing). To act as a stop, set HOLD BARS:CN (continuous, infinite) so it is valid.

Uses:

- If you want to just fill between two groups, then set Hold Bars to "--" and both Holds to bars.
- If you want to loop up to specific block always, (so group top plays once) set just the "Jump To" to the row number.
- If you want to end Play of this track here, Set Hold Bars to CN. A pulse on the MIDI/RS input will release.
- If you want to Loop in one group until a certain trigger, set trigger(s) and "Jump To" row. (Must wait min 1 bar / loop)
- If you want to MIDI remote-control the continuation of a track, set Hold Until to M:Remote. (Assuming learned prior)
- If you want track to continue when Song Loop 04 plays, but 2 bars in, set Hold Bars to 2, and use SONG:02 & BARS
- If you only want to proceed once TRAX1 and TRAX2 step together, set Hold Until to TRAX1, And Until to TRAX2

FYI's:

The triggers assigned to a conditional only become active once the conditional block is entered into. Previous triggers will not be active upon entry, therefore an immediate JumpTo is not possible. This also means a track conditional cannot be triggered by itself.

Conditional Blocks in Play List will not send a trigger, only regular play blocks can.

4. [--EDIT→]

This is a shortcut to editors related to the track / block you double-clicked on.

If a particular block is double-clicked on, direct entry into sequencers is possible (except with Song track):

- Song Block: Jumps into SongFX QB, but for selected Song Loop#. If Playing, will play selected with **LOOP ON**.
- Layer Block: Opens the Layer Sequencer # for editing
- TRAX Block: Opens the TRAX Editor for selected TRAX tracker Letter.
- Auto Block: Opens selected Automation List for viewing/editing.
- A Conditional: Opens the selected conditional block's list of conditions/actions.

*** Note: On entry from the track header, the QB that opens acts the same way as when in main screen, i.e. hold to enter a list or menu. You can't enter the editors from the QB, except for the SongFX QB, so use direct block editing instead. Song Loop's FX being edited during play will Loop & Hold once present Song Loop is finished So adjustments can be heard.**

5. [*PLFX*]

IV. B. 5.

This will enter the Play List FX Modifiers list for Song Loop Blocks, Layer Blocks, TRAX Blocks, or Automation Blocks. PLFX can set any parameter in the module when the selected block is played into.

Attached PLFX will load the parameter(s) and change them when the block is played, but won't return to the previous value once exited, so it's up to the user to change it back with a consecutive block, thus, there must be at least 2 blocks in the track. Each track can have up to 7 different PLFX "bundles" to select from (PLFX#1-7).

Double-click on a block and scroll down the pop-up to [*PLFX*] and click. A list of PLFX parameter modifiers will open. If there is no PLFX for this block, the top entry will show **PLFX#:-** . This must be changed to 1 to 7 to activate.

- To add a parameter to the list, scroll down to an empty number and click to select it.
- The main Screen will appear with the "S" LED flashing as a reminder.
- Find a parameter you want the PLFX to modify and click to highlight it.
- Now adjust to the value you want for this PLFX but leave it highlighted.
- Press the "S" button to save. The PLFX list re-appears with the name of the parameter in the list as a reminder.

Do the same with a following block

While Playing, be careful when doing consecutive PLFX entries as the former ones can and will modify the value before you save it. This won't be apparent on the display. I'm guilty of doing it myself, but if you can get the timing right, it's possible!

PLFX Considerations:

- * The same PLFX bundle can be used in multiple places on the track, so one group can use the same PLFX# as another.
- * Be careful of conflicts with same parameter's being modified by other track's PLFX.
- * If you want to test the affect of a parameter on a certain block (i.e. a TRAX) isolate block so it loops alone, remove after.
- * PLFX can not be attached to a Conditional Block (road bumps).
- * Assigning a JumpTo (or Loop:On!) to a block's PLFX can cause a lock-up in the Play List. Do JumpTo's carefully.
- * Assigning [SONG:nn] parameter to a PLFX will load a different Song Project and start playing it. Make sure you save first!

6. [TRANSPOSE]

This action will allow you to uniquely transpose a single Block +/- 12 semitones (0 - 12 - 24). In keeping with the MIDI note vs. classical note offset of 12 semitones, the "center" of this transpose is 12... but it also fits better into the grid! Double-click on a Block and scroll to [TRANSPOSE] in the pop-up, click and scroll. Click again once finished.

As each block can have it's own transpose, following a melody that changes over bars (measures) can be accomplished easily with the same sequence. With Different sequences with their own scale or transposition due to a modifier or just the key it was in can get very interesting and adds a bit of pizzazz!

Other transpose offsets will add to this one so the original progression relatively stays the same. If the presently selected block is being played, the transposition will be immediate, if not then will take affect once the block is played.

7. [+ INSERT]

This inserts a space in the Play List by shifting everything below selected cell down, leaving an empty cell. If the step# (far left) column was selected, then insert will be across the grid. This can be used with [FILL:nn] (see below) to open up multiple cells.

8. [- REMOVE]

This will remove the selected cell by shifting the ones below up. It can be used to join groups or remove a block in the group. If the step# (far left) column was selected, then blocks will be removed across the grid. This can also be used with [FILL:nn].

9. [:DELETE:]

This will delete the selected block(s) from the cell(s) without affecting others around it. This can be used to split up a group. If the step# (far left) column was selected, then blocks will be removed across the grid. This can also be used with [FILL:nn].

10. [FILL:nn]

This QB can be turned on, set, or turned off. It can be set once the pop-up is in view and has no Action of it's own. Once set to a Fill Size, 2-64, many actions will use this value to determine the range of blocks affected below it. This is useful for multiple-deletes, adds, size adjustments, inserts or removes. It also can be set to be the initial Copy or Paste vertical size but will be updated by scrolling during copy/paste modes.

Click the QB to set a Fill size, click again to exit the QB. Don't forget to turn back to 1 when finished!

11. [SHIFT +/-]

Shift will move all blocks in a track downward (scroll right) or upward (scroll left). Selection is not important as long as it's in the track you want to shift. To shift the entire Play List, double click in the Step# column (far left). The selected area will flash briefly after [SHIFT +/-] is selected.

Shift can be used with [FILL:nn] to set a range to shift, which will rotate up or down through the range.

12. [:COPY:]

IV. B. 12.

To copy a block or range of blocks, double-click the top left corner of the area you want to copy, then select [COPY]. Use single clicks to toggle horizontal/vertical to create the hi-lighted range. Once ready, double-click to copy. If [FILL:nn] QB is turned on, then the initial sized of hi-lighted blocks is preset, but can be adjusted vertically after.

13. [:PASTE:]

To paste a previously copied range, select the upper left corner of the range. This should be on the same track as the copy. If too far left, only the tracks at, & to right of copied area will be changed. Tracks are not interchangeable. If the vertical Paste range is larger than the Copy range, blocks will repeat (as in TRAX Editor) which may be desired. So with top left corner cursored over, double-click and select the [:PASTE:] QB. As with copy, create the range of hi-lighted blocks, then double-click to paste. If you make a mistake, double-click any cell for pop-up and scroll down to [<<RECALL] to undo to the Copy point.

14. [SOLO]

This pop-up QB is simply to toggle Soloing of the track you double-clicked in. While Solo'd, the QB will be hi-lighted while non-solo'd tracks will be dispersed. Mute takes precedent over Solo. Exit pop-up with [CANCEL]

15. [MUTE]

The Mute QB is similar to the Solo QB. Double-click anywhere in the track you want to mute, and scroll to the Mute QB. While muted, the [MUTE] QB will be hi-lighted. Mute has priority over Solo. Exit pop-up with [CANCEL]

**Note: An automation, PLFX, or MIDI Remote Control Note/CC can be programmed from here, the same as from any QB in the main screen, either will function the same way.*

16. [* RECORD]

This pop-up QB will turn on record for the selected track (except for the Song track) just like in any QB in the main screen, with the exception of record settings access. This must be done from the main screen QB.

TRAX Record will toggle on / off, while Layer Record will request a Bar count first. *Note that Layer Record will not turn off until present Layer recording is finished.

While in record mode, a recording track will turn on / show the record symbol.

Record on the Automation track will arm for a new automation if not presently within an automation. If is within an automation, then new modifications will be added into the automation list. Exit pop-up with [CANCEL]

17. [LOOP:OFF]

The Loop QB in the pop-up performs the same function as in the main screen except there is no menu under it. Anywhere on the grid, double click and select [LOOP:ON] to begin looping the Play List. Exit pop-up with [CANCEL]

18. [<<RECALL]

Select this QB to recall the entire grid state at the time of either:

- Last entry into the Play List grid from the main screen
- Last Copy of the Playlist.

19. [CANCEL]

Use this QB to exit the pop-up. Used after setting Fill, Solo, Mute, Record

20. [:EXIT:]

Exit the Play List. This can also be done by press & hold anywhere on the grid.

Play List Notes and Tips:

- Scrolling over a Block will display any PLFX#, i.e. "P4", then a second later, it's size in bars. "C+" is >99 bars.
- The top-left corner icon may assist with symbols for horizontal/vertical, copy, paste, add new etc. It shows after a click.
- Keeping groups of blocks aligned is useful when live-changing from one part of a song/beat/progression to another
- Play List Blocks can be assigned for Remote Control Arming by selecting the block or row to open pop-up, then scrolling up to [=ARM=] but not clicking it. Send your MIDI CC or Note (while in a Remote Learn), or PLFX "S" button, to set!
- Conditional Blocks can be deleted to split a group but it's settings won't be lost. The Conditional # remains available
- Conditional Block count on any track can be any number but remember there's only 8 unique ones per track.
- When Recording in Play List with LOOP:OFF, remember that the present playing block will be recorded to! With TRAX you could record to several different Letters on the track, this may or may not be desirable. With Layer recording, a longer bar setting may change the length of the whole layer step sequence. All Steps will include new recording until edited out of the Sequence.
- All blocks armed before or during Play will be set to start at those points if Play is Stopped, the re-started.
- Solo'd track(s) will visually "fade" other tracks, as well as muted tracks will appear faded; for reference. Solo'd Layer Sequencer Steps will change the track header as well to show the solo tracks as does Solo'd Layer QB with a small "S"

V. MIDI Remote Control

The Sequarallel has numerous Remote control methods and types. A track remote that can be easily configured to use a set of notes to do basic per-track controls like mutes, solos, gate FX, play/stop, and record. The TRAX Trackers have their own special sequencer remote controls on a separate channel, and the Universal Remote can control pretty much any parameter or setting. CV remotes allow control from a CV input jack, CC5, CC6, and CLKout if not used for outputs.

A. Universal Remote Control

The universal Remote control (found under the **[REMOTE:nn]** QB, can control a single value with a MIDI note or CC. Up to 128 CC's and 127 Notes can be assigned to control almost any parameter, switch, or value. This Remote Channel can be changed with the **[REMOTE:nn]** QB. (1-16, or NO = off)

There are two sets of remote assignments: "Global" for all Song projects to use, and "Song", applicable to only present Song Project and is saved along with the project. Either or both can be selected to Learn.

Another selection **"*USE..."** sets which remote lists to use,

*USE GLOBAL	Only use Global CC and Note lists
*USE SONG:nn	Only use Song (project) CC and Note Lists
*USE GLOBAL 1ST	Use Global List if this remote exists, if not then try the Song Lists
*USE SONG:nn 1ST	Use Song List if this remote exists, if not then try the Global Lists

The latter two will prioritize one over the other, i.e. Song 1st will use a set remote control if it exists, and if it doesn't, then will attempt to use the Global. This is useful for replacing a more specific parameter that may not exist in present Song project

1. MIDI CC or MIDI Notes?

Using Remote Notes:

- It is generally more logical to assign parameters that are on/off to be controlled by notes. Hold note > 0.75 second for off.
- Multiple Notes can be used to set the same parameter to different fixed values. No need to hold for "off"

Using Remote CC's:

- CC's allow adjustment of a parameter over the range. Some parameters are 1:1 CC Values, some are not (see appendix)
- One CC knob can control the full range of a parameter and indicate relatively the setting.
- CC's may not be good for selection of more than 3 or 4 functions / options as there is no indication.

There are two methods to program remote Notes & CC's, via MIDI Learn or editing a list of Notes & CC's

2. MIDI Learn Method

During MIDI Learn, the MIDI CC's are polled over one second. The CC# with the most events gets to be the remote control. Notes are learned immediately. Remote learn works with both Panel MIDI input and LINK MIDI input. Ensure that you are not blocking the input channel for remote (**MIDI PUSH, CHANNELS**)

a) Make sure the **[REMOTE:nn]** QB is showing the channel you wish to use. Next, press and hold the QB to set learning type(s) and which you wish to program.

- ▶LEARN: GLOBAL These remote configurations work across any project
- ▶LEARN: SONG: These remote configurations are specific to the present Song project

Select and set to "YES" to arm for learning to either or both lists.

b) Find the parameter you wish to remote control and select it to highlight. Don't press encoder to exit!

** If using a remote Note, it's important to adjust it now to the value you want to the note to set parameter to.*

c) Move the MIDI CC knob / control or play Note to assign. The highlighted parameter will return to normal.

d) To exit this programming mode, press the "S" button while nothing highlighted, or return to Remote menu to turn off.

Important Hints:

- With non-highlight-able parameters (i.e. Solo, Mute, Loop:on, Record etc) scroll to it and click at least once to the state.
- Parameters will not change remotely until LEARN modes are turned off (do in menu or "S" button)
- Most parameters (except QB's) won't show change unless menu / list is moved. This is to save processor power.
- To Remote Arm a block in Play List to Play, double-click on block and scroll pop-up to ::ARM:: then send your MIDI.
- Envelope creation windows, Song Loop setup, and Remote Menu / list cannot be remote controlled (obviously!)
- See Appendices ([Remote Implementation](#)) for an extensive list of parameters and if they can be controlled. Almost all can!

3. List Program Method

V. A. 3.

The List program method is very similar to the MIDI input method above except that the S button is used in place of MIDI input. In the long list, a CC# or Note# is selected, which jumps back to main screen to navigate to a parameter to assign to it.

For a Note#, select the parameter to highlight, and adjust to where you want it to be when Note# is pressed, press "S" button to save & return to remote list. The original value (before adjustment) will be recalled if Note# is held > 3/4 of a second. * *This can be useful for momentary changes while Note# is held down!*

The original value will be whatever was there before you highlighted the parameter. This will be the value returned to when the remote note is held > 3/4 of a second.

For a CC# Simply highlight the parameter and press "S". As the CC value will control the parameter the highlighted value doesn't matter.

Under the [REMOTE:nn] QB, you can select which list to view. Initially the "USE" selection with change list in view.

▶ EDIT LIST: GLOBAL/ SONG:nn	Select Which Lists to view and edit
▶ EDIT REMOTE TYPE: CC# / NOTE#	Select CC#0-127 or Note 0-126 List (Note127 is reserved, avoid use)
(CC List examples)	-Names of parameters to control remotely
▶ 000: CC5 I/O DIR	CC # 000 change direction of CC5 jack
▶ 001: ORD:1 CYCLE DIR	CC # 001 change direction of CV Mode Order Cycle
▶ 002: --	CC # 002 not assigned
▶ 003: TRX:2 MIRROR LOW	CC # 003 change TRAX:2 Mirror's low note cutoff

Selecting any of these CC / Note numbers will exit the Remote QB to find the parameter. To abort mission, just re-enter the Remote QB.

To delete selected Remote number, scroll to a non-parameter QB (like MIDI PUSH) or unselected parameter and press "S"

4. Global Learn or Song Project Learn?

The big question is whether to use your remote setup Globally, with every song project, or locally to each Song?

This depends on many things such as:

- Your controller size. How many knobs do you have, or want to use?
- How much do you want to control, or do you have a specific target? (i.e. TRAX 1 Note FX 1)
- Do you want to just add some remote control per Song Project as the need arises?
- Are you going to use Track Remotes Note overlay? (see next section)

So really, it's up to you. My method is to use the same 8 sliders for Track Levels on a Global Remote, then 3 knobs above each slider on a local (Song) set for various controls for those QB's that are useful to change.

Cautions:

Because some controllers (and many software's) send MIDI CC's according to standards, usually during a preset change , program start, power-up, it might be a good idea to monitor what is sent if you have the facility, or consult the owners manual. The manual won't always mentions these though, so it's best to plug it into a computer running MIDI-Ox, to see if there are any unknown's.

Certain CC's will be sent by almost every MIDI output software at startup and when the Play button is hit in the software. The most common are CC#123, CC#007 (volume), CC#010 (pan). If you plan to use the remotes this way then stay away from those! Enter learn mode with caution as well. The Sequarallel only knows it's a CC message on it's remote channel.

B. Track Remotes

V. B.

Configurable by Octave, this Remote is to control toggled and momentary functions with MIDI Notes, and uses any 3 octaves from the offset **TRACK REMOTE:nnn** in [SETTINGS]. These 3 octaves on the Remote channel will take priority over Song (local) remote notes, and Global remote notes, always, when not set to "---" (default setting is off) Unassigned notes in this array (see diagram below) can still be used as regular Remote Notes, allowing some customization when using this type of remote control; either Globally, or per Song Project, within the 3 octaves.

To use these notes, first select a function, i.e. Solo or Gate Mute (gated un-mute!) then press a note(s) corresponding to TRAX, Layers, or Song to apply. As a bonus, there are 13 notes at the top to set master transpose.

Solo, Mute, and Record *toggle*, but if held >3/4 second will return to "off". Play & Stop are like pressing the "P" or "S" buttons. Gate Mute and Gate FX are momentary. Gate mute can be recovered to un-muted by selecting mute to toggle tracks again. Gate FX will allow tracks FX to be momentarily active, so Gate Reset→track must be used to recover affected tracks.

*New! Kill Last key affects only the Layer tracks and works like the [KILL LAST] QB stripping away Layers.

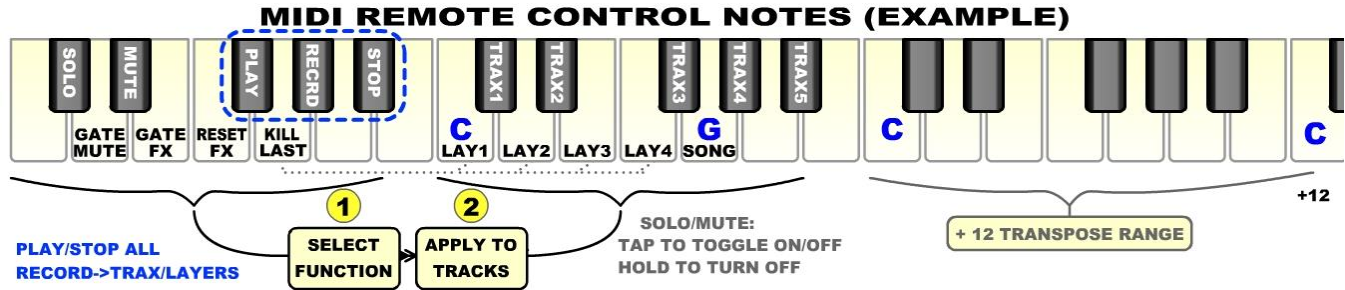

C. Remote CC TRAX Step Control

During a TRAX record session, notes can be added, deleted, cycled in, and recalled via user defined notes on the keyboard. In addition to that, a group of MIDI CC's, set by user, can be used to tune each step like a traditional modular hardware sequencer. Another single MIDI CC# is used to select the function of the group of CC's. These functions are:

- | | |
|--|--------------------------------------|
| RE-NOTE: Changes the Pitch of Step (Works with Scale!) | NOTE_FX: Select NoteFX# 1-8 for Step |
| VELOCITY: Adjusts the Velocity of a Step (All lanes) | FX_MAP: Turn on/off FX Mask Steps |
| LENGTH: Adjusts the Note-Lengths of a Step (to >5 steps) | KILL: Removes a step or recalls it |
| DELAY: Adjusts the delay of a Step (0 to 22 ticks) | SHIFT: Shifts Lane 1-4 up/down |

*Please note that the TRAX QB's Record mode must be on for any changes to take affect. Settings are under the [RECORD] QB in any TRAX QB Drop-down, or in the TRAX Sequencer's Pop-out QB's. This Remote Channel can be different than the Universal Remote Channel shown in the [REMOTE:nn] QB. This is better covered under the TRAX Tracker Section of this Manual.

Also, please check out tutorial video on this feature at <https://www.youtube.com/watch?v=wqyKpFKBSxw>

D. CV Remotes (CV Inputs)

The 3 CV input jacks, CC5, CC6, and Clock Out (if not used as a clock output) can be assigned an internal remote function. They can also be assigned to send a MIDI CC on a MIDI channel, Pitch Bend, After Touch messages etc. Under the [MIDI PUSH] QB, you will find the following:

- | | | |
|---|------------------------|-----------------------|
| -----CV IN / OUT | | |
| ▶ CC5 DIRECTION: INPUT | | CC5 DIRECTION:OUTPUT: |
| ▶ CC5 FUNC: CC#---, PBEND, AFTER-T, MIDI GATE, MIDI NOTE, MIDI VEL, PLAY, STOP, LEARN | | CV MODE |
| ▶ CC5 = CHAN: nn | IF LEARN: "PARAM NAME" | CV MODE |
| ▶ CC6 DIRECTION: INPUT | | OUTPUT: |
| ▶ CC6 FUNC: CC#---, PBEND, AFTER-T, MIDI GATE, MIDI NOTE, MIDI VEL, PLAY, STOP, LEARN | | CV MODE |
| ▶ CC6 = CHAN: nn | IF LEARN: "PARAM NAME" | CV MODE |
| ▶ CKO DIRECTION: INPUT | | OUTPUT: |
| ▶ CKO FUNC: CC#---, PBEND, AFTER-T, MIDI GATE, MIDI NOTE, MIDI VEL, PLAY, STOP, LEARN | | CV MODE |
| ▶ CKO = CHAN: nn | IF LEARN: "PARAM NAME" | CV MODE |

If any jack is set to Output, the **CV MODE** directive will appear. All jack outputs are controlled via the [CV MODE:n] QB

To set a jack to act as a remote control, *

- select CCx Function to LEARN and click to enter.
- This will Change the CHAN:nn Parameter to the Name of Parameter to control or a blank space if empty.
- Select this Name and the menu will exit, with STOP LED flashing.
- Navigate to the parameter you want to control and click to highlight it.
- Press the "S" Button to save. LED will stop flashing and menu will re-appear with the name of new parameter.

*(1) CV Remotes are set per Song Project. There is no Global lists as with MIDI Remotes.

*(2) For a switch type of parameter (i.e. Solo, Mute, Record etc) the CV voltage must pass 1 volt to be in an on state.

*(3) Any +/- control (Transpose, Fine tune, Swing) requires a negative voltage to drop below zero.

*(4) Patching CV inputs to fast changing signals, like VCO or fast LFO will quickly use up MIDI bandwidth if sending MIDI, and will put a heavy load on the processor with learned parameters. Also the screens will not update in this case.

*(5) CV Parameter control will be suspended while in any Menu that it is assigned to. This prevents "value lock-up" due to the constant changes possible with CV. Also it allows adjustment of the parameter without being overridden.

VI. Envelopes

The Sequarallel has 4 Envelopes to use for various CV and MIDI modulations. Envelopes can be output from jacks CC1 through CC6 as unipolar or bipolar, then once assigned can also be used to modulate a MIDI controller (CC), Pitch Bend, or After Touch, on more than 1 MIDI channel. **Keep MIDI bandwidth in mind when assigning multiple channels / envelopes!*

There are 3 main types of envelopes, ADSR style, Drawn via CV, or drawn by Parameters entered. Once an envelope has been created, it can be used by multiple triggers assigned via CV MODE QB settings (see III. CV MODE), or Envelope settings.

To access the different method and Settings (next) click on the Envelopes QB (or just hold to enter Settings) then scroll down:

- [ADSR EDIT] To make an envelope by poles and curves. See Section B. below
- [CV DRAW] To record an envelope from CC5 input using and LFO or other. See Section C. below
- [PARAMETER] To build an Envelope using parameters to control a sine waves. See Section D. below
- [COPY FROM] To import an envelope from some other Song Project. See Section E. below
- [EXIT] Just escape the Envelope QB. This can be done by clicking on ENVELOPES as well.

To enter a Method to make an envelope, click then select which envelope in the preview pane you wish to modify. This will clear a previous envelope but you can use the "Copy From" QB above to recall an envelope from even the present project.

A. Settings

Click and hold on [ENVELOPES] QB to enter the preview panes, select one to enter the settings menu. This menu is as follows:

- ▶ **ENV SIZE:n:nn** Adjusts how long the envelope will last in beats:ticks (MIDI sync so will adjust with tempo)
- ▶ **TRIGGER:** Direct trigger source via CV in, Bars, Beats, Clock (always), MIDI Notes on Channel, single Drum, or free running. ** Drum Trigger # selection only includes notes in present drum grid, see III. C "Drums Mode"*
- ▶ **CV OUTPUT:** Jacks CC1 to CC6 direct assignment. Can be used with other but may clash!
- ▶ **MIDI OUTPUT:** Output as MIDI CC#, Pitch Bend, After Touch. **** Envelope must also be assigned to a Jack to output MIDI**
- [01] [02] ...etc: MIDI Output Channel.

The latter settings can be left at default if you want to only output envelopes with MIDI notes & events from the CV Mode Sources and configurations. If both are assigned, one can be used then the other providing two different envelopes on the same jack. One will override the other or clash if played together on the same jack. This is safe to allow.

B. ADSR EDIT an Envelope

By default, all envelopes are this type. One would possibly use these to control a filter or a VCA on the same row as the Gate & CV, or to modulate something completely unrelated. Press the [ENVELOPES] QB and scroll to [ADSR EDIT] and press.

- [POLE] Click to adjust a POLE position. S (Sustain) has two.
Click to select a pole, then click to adjust, click to show QB's again
- [CURVE] Click to select 1 of 3 curves. Click to adjust outwards or inwards curves. Click to show QB's again.
- [SET] Click to update Envelope with new (to hear difference if auditioning)
- [EXIT] Finalize envelope and exit ADSR screen
** Note: The actual type of envelope is AHDSR: Attack, Hold, Decay, Sustain, Release.*

C. CV Draw an Envelope

This method of envelope creation is just as it sounds, drawing via CV. As the recording is almost live, one can hear the way it sounds (if auditioning it) immediately. Press the [ENVELOPES] QB and scroll down to [CV DRAW] and click to select an envelope to modify and enter the drawing screen.

Patch your modulation source (LFO?) to CC5 jack. It doesn't matter if it is set to be an input as it will be once in this menu.

- [TRIM] Trim and fit the recorded waveform so the start and finish are same level. Use if will be free-running as LFO.
- [UNDO] Revert to last recorded
- [REC] Click to start recording, click to stop recording. The last full waveform shown will be saved.
While recording, scroll up/down to adjust the sample rate. The display will show the difference.
** Bonus Use: Record can be used to monitor a waveform from any source like an oscilloscope!*
- [EXIT] Exit CV Draw, the envelope will already be saved, but don't forget to save the project!! (SAVE:EDIT)
** Note: The envelope levels will be same as recorded so if you want bi-polar output, the original source must also be*
** See next page for some cool tricks with this Envelope mode*

D. Parametrically Draw an Envelope

VI. D.

Parameters can be used to get a desired result in a waveform. I find this can source better shapes for filters as triggered by beats or inputs. There are quite a few parameters, but it gets simple once you have played with them a bit. The selection of a parameter will display the envelope as you adjust that specific value, making it easy & live. The auditioning though may seem a bit jumpy as waveform changes. Here is a list of the parameters you can adjust:

▶ PHASE	The start of the sine waveform in degrees.
▶ FREQUENCY	Frequency (overall) of waveform. Relative to total length.
▶ FREQUENCY RAMP	Increase or decrease in frequency over total length. Linear.
▶ AMPLITUDE	Wave form Peak to Peak (+/-5V or 0-5V)
▶ AMPLITUDE RAMP	Increase or decrease in level over total length. Set around zero volts
▶ OFFSET	General voltage offset of waveform.
▶ OFFSET RAMP	Increase or decrease in voltage offset (good for zeroing end of unipolar)
▶ WAVE STEP	Resolution of waveform (bit crush)
▶ MIX MULT BY	Mixed waveform's frequency relation (if use)
▶ MIX LEVEL	Mix waveform level of injection to main waveform
▶ WAVE FUZZ	Randomizes waveform at high rate (thus fuzz)
▶ BI-POLAR?	Switch to Bi-Polar use
▶ TRIM LFO?	Trim start and finish to match voltage for free-running (LFO) use.
▶ RESET	*Reset all parameters here! No undo.
▶ EXIT	Done, return to main screen

** Note that none of these parameters can be Remote controlled due to editing mode → envelope structure updating.*

*** If CV Mode setting for assigned jack is not set to Bi-polar, then waveform won't be as indicated (chopped neg. side)*

E. Copy From

Another envelope from a different Song Project can be imported and used in this one by simply scrolling through them and picking one out. Press the **[ENVELOPES]** QB and scroll down to **[COPY FROM]** and click to select an envelope to replace.

Click on "COPY SONG:nn ENV:n" then scroll away. The name of the Song Project will be shown at the top. Click to save, the EXIT to return to the main screen.

Envelope Tricks:

Using CV Draw to record from another envelope's CCx output can make a new, more complex, envelope.

Use CV Draw as an oscilloscope, adjust speed by scrolling encoder up/down while in **[REC] (up to audio frequencies)**

Use CV Draw to record a trigger sequence, then trigger the burst with notes or Bars+Beats / free-run etc.

When parametrically creating an envelope, ramp the amplitude to nearly zero for return to zero volt state.

Two different Envelopes can occupy the same CC jack with a trigger source from Envelope settings and another from the **[CV MODE]** settings. If triggered while another is active, one will override the other depending on it's duration.

To speed up an envelope, use Envelope settings rather than the X1, X2 in **[CV MODE]** . This will keep it's high resolution.

If you accidentally choose the wrong Envelope type to edit using ADSR, CV Draw, etc. (this will clear on any adjustment if a different type) then you can recover it by using the Copy From feature (above) and copy from your last save of this Song Project. That's why it's important to do the occasional **[SAVE:EDIT]** while working on a Song Project.

As Envelopes can be triggered from an outside source (CC5 jack or MIDI notes) they can be very useful for "automating" an element of your rack at a predictable rate. One trigger source could start all 4 envelopes.

VII. Utilities

A. MIDI PUSH Button

When this button is pressed, then released, a variety of MIDI Messages are sent. Some are essential "vitals", while other are configurations like MIDI PC (Instruments) and MIDI CC initial values set by you. This is to update a recently connected synth, or change from another Song project if the synth wasn't online when the project was loaded.

The CC5/6 and Clock Out CV input mode functions and direction are also set here, and finally the MIDI, LINK, & Thru Ports channels filters can be set here. I will list each section of MIDI PUSH below.
Press & hold [MIDI PUSH] to enter menu to make all of these settings!

1. **CC5, CC6, CKO CV Inputs**

At the top of the menu you can set the CV directions to Inputs if you wish to use them that way. Note that when set to Output, the "Function" and "Channel" will lock to "CV MODE". This means you must go to the **[CV MODE:n]** QB's menu to set those.

CC5 DIRECTION:INPUT	Must be set to input to use a function
CC5 FUNC:xxx	Select a function of the jack as input (see below)
CC5 = CHAN:nn	Set MIDI Channel of this jack if set to do a MIDI function
CC6 DIRECTION:INPUT	Must be set to input to use a function
CC6 FUNC:xxx	Select a function of the jack as input (see below)
CC6 = CHAN:nn	Set MIDI Channel of this jack if set to do a MIDI function
CKO DIRECTION:INPUT	Must be set to input to use a function
CKO FUNC:xxx	Select a function of the jack as input (see below)
CKO = CHAN:nn	Set MIDI Channel of this jack if set to do a MIDI function

CV to MIDI:

The first set of Functions for a *CV input on selected jack* are MIDI CC#, Pitch Bend, and After Touch. Selecting one of these will send value from CV input on the selected MIDI channel to the MIDI & LINK ports (as long as channel isn't filtered, see below).

CV to MIDI Notes:

The next CV input to MIDI functions are **MIDI GATE** and **MIDI NOTE**. This is a way to generate MIDI notes on the selected MIDI channel via CV input. One input can be a Gate while the other a CV value @1V/Octave to select the notes. - or - without a Gate input, changes in the CV can create fixed length notes (max length based on clock)
Each method has it's merits.

CV Mute/Solo:

The fast Mute or Solo control can be set to control a Song, Layer, or TRAX tracker Solo or Mute when the CV state is high.

CV Remote Control:

The last CV Input Function is a general Remote Control of any parameter in the Sequarallel. This is much like the MIDI remote control but must be configured by navigating to the control you wish the CV to modify, rather than the "learn" method.

i.e. I want to use a CV input to lengthen TRAX 1 tracker's notes.

Select REMOTE function. This will exit the PUSH Menu back to the main screen. Scroll up to TRAX 1, click for it's drop-down then scroll to **[LENGTH:nn]** and select to highlight it. Press "S" button on the panel to set.

You can now test the CV input on then note lengths.

* Note: Some "centered" values (i.e. pan, Transpose, swing, limit) will require CV voltage negatives to adjust < 0.

* See [Section V. D. \(CV Remotes\)](#) for more

CV MIDI Channel:

The "to" MIDI Channel can be set, but only 1 to 16. (Sorry, No MPE Notes from CV as they don't / can't over lap!)

CKO Clock Out Jack:

This special jack can be used as a CV input, just like CC% & CC6, by selecting CV INPUT or AUTO. Be cautious if use Auto though as if there is a MIDI clock input, then the CKO jack will indeed be a clock output.

*Note: CKO jack input, because of extra switching hardware isn't as accurate thus is a bit fussy as a CV2Note input.

:SONG FX:→

As a bonus, CV inputs, if set to function of Notes, can be modified by the 17 Song Loop FX transpose or scales (always)

TRANSCOPE CV IN: YES

The present SongFX transpose will be applied to the CV input notes.

SCALE CV IN: YES

The present SongFX Scale will be applied to the CV input notes.

Push Vitals?

The Vitals are centering Pan & Balance, setting Volume to 100, resetting any RPN pedal that is engaged (re:sustain) It's fairly important to be able to reset these as something on the input may have left the bus in a bad state. Push Pitch Bend option is probably always going to be yes.

Pitch Bend Range:

This sets the actual range your synth will "see" as the pitch bend is moved from end to end. Some synths can only do +/- 2 semitones, while most can do at least +/- 12, and higher end synths will pull +/- 48 semitones (which to me is a bit much!)
**Note: If you are going to use that much range, keep in mind that the CV to MIDI resolution won't be super smooth*

PUSH MIDI CC's:

The next menu entries allow you to enter up to 4 different CC "presets" per channel, making a total of 64 presets. This can be useful to recover CC's that you know will be changed by the Sequarallel or MIDI inputs during this song project's play. Simply select the CC channel first, then a CC#, and finally set the value you wish it to have when MIDI PUSH is pressed.

Instruments (MIDI PC):

Here you can set a PC / instrument on each channel. They are all displayed at once for reference and when selected will show the instruments name across the top if you are referencing to a standard GM set.

CHANNELS Filters:

At the very bottom of the PUSH menu is a selection of MIDI I/O filters. Click to select one to enable or disable channels for:

- MIDI INPUT Filter certain channels from entering on panel MIDI port
- LINK INPUT Filter certain channels from entering on LINK backplane port
- MIDI OUTPUT Filter channels from being sent to Panel MIDI port
- LINK OUTPUT Filter channels from being sent to Backplane LINK port
- MIDI→LINK Filter channels from going through from MIDI input to LINK output
- LINK→MIDI Filter channels from going through from LINK input to MIDI output

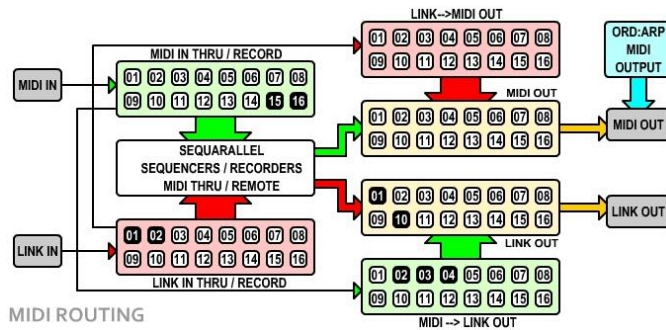

This diagram describes the basic MIDI Routing. In this example, channels 15 & 16 on panel MIDI input are blocked, while Link input chan's 1 & 2 are blocked.

All MIDI input channels (except 15 & 16) can pass thru to LINK output except chan's 1, 2, 3, 4 & 10, while sequences can still be sent on LINK output channels 2, 3, & 4 but not on channel 10 (LINK may feed a non-percussion synth)

All LINK input channels (except 1 & 2) can pass to panel MIDI out.

The ORD:ARPEG output bypasses this routing as is a MIDI add-on for it's primary function of Arpeggiating Gates & CV's and can be controlled by each jack's Arp.

SongFX also has a Channel blocker exclusively for Song Loops, thus each loop can filter specific channels (i.e. removing percussion or backing channels)

The [TUNE:+00] QB can be used to immediately adjust all 1V/Oct CV outputs +/- 99 cents, which is exclusive to the present song project, or held to enter a menu of CV tuning settings. These settings are Hardware Global, meaning they don't change with the Song Project. This is assuming you may want to use the same VCO's with different projects, so the settings can be changed with hardware, rather than project #. Under the [TUNE:+00] QB the listing is as follows:

1. Fine Tune Jacks

FINE TUNE:ROW n: +/- nn Individual CV Fine tune offset +/- 99 cents. These settings remain always. After an auto-calibrate session, these can be used to intentionally de-tune a VCO, or bring in a similar VCO that is slightly different from the one that was calibrated to.

FINE TUNE:CV IN: +/-nn Fine tune ADC input offset amp to 0 by adjusting (should be at 0 as tuned, by may drift over time)

2. Set Zero-Volt Note

-- ZERO NOTES --

ZERO NOTE:ROW n: nn These set the MIDI note# that will output zero volts which, in the case of a non-bipolar VCO is the lowest note it can play (or how you set it to be the lowest note). Default = Note # 36. This can also be used to offset for VCO's that start at "A" on zero volts. (set to 33)
* **Note: Not all VCO's will align to 24, or 36, but may be 23/25 or 35/37. Test by ear and set.**
* **These ZVN settings are remembered globally for each VCO**

3. Select VCO Calibrations

-- CALIBRATES --

=>**EDIT NAME** Toggle on to edit a name of the presently selected VCO Calibration below.
Rn:VCO n SETUP ROW n Select one of 8 Calibrations per jack (row) to use presently connected VCO.

To edit the name of a VCO Calibration (before or after the calibration has been completed) click =>**EDIT NAME** to highlight it, then select a name to edit. A single letter will highlight, click to adjust it, then click and scroll to move to another letter. Once done, scroll through past the name and the arrow will re-appear to select another VCO.

Each row can have any of it's 8 VCO calibrations selected, which can also be changed while in the **CV MODE QB** menus. If you wish to accurately use a certain VCO with any jack, be sure to auto-calibrate it with all 4 CV jacks as each will have a slight variance. (see next section) Remember to name it aptly, especially if you have a lot of VCO's...
i.e. my SDS_VCO's are called SDS1, SDS2, SDS3.

4. Auto-Calibrate to VCO

Below the VCO selectors is an entry CALIBRATE ROW:n. Select this and scroll to which CV (Row) you will be calibrating. Make sure the VCO name is visible for the row you have selected. Click to enter the calibration window, which looks like this:

Important:

Before patching VCO audio into MIDI Input Jack, change MIDI Jack to be a RS input by setting ►**MIDI IN:JACK** to **RS+CAL**. Failure to do this will put audio input to MIDI input so could cause all sorts of random activities (including SysEx) possibly causing permanent changes to the Song Project that may not be immediately apparent.

CALIBRATE ROW:n
VCO NAME ROW ETC
=====
PRESS KNOB TO EXIT
PRESS (S) TO START

- 1 - Verify the VCO name selected is the correct one. (section 3 above)
- 2 - Switch the VCO output to clean square wave, no modulation, no envelope (always on)
- 3 - Patch VCO output into Sequarallel's MIDI IN (up to 10V p-p)
- 4 - Patch the CV output from row to be tuned into VCO's Frequency CV input
- 5 - Press "S" button on panel to begin calibration.

As the VCO is tested, NOTE:nnn will change on the screen. Screen will exit once completed.

- * **Note, some digital VCO's (i.e. Disting Mk4 B7 VCO) output "dirty" signal. This may not tune properly. (i.e. Use B8 on Disting!)**
- * **Some VCO's can't go below zero volts. In this case the unusable notes will be rolled back up 1 octave so notes still useable.**
- ** **You can possibly test what the signal looks like by using [ENVELOPE:CV DRAW](#) recorder screen at lower audio frequencies.**

MIDI Input as Reset input:

If you are not using MIDI input, it can be configured to be a TRAX reset input. This affects no other Sequencers so can be used exclusively to restart a TRAX sequence. It will still align to the Clock on steps, but not on bars so can be used to shift the sync from play start. Set ►**MIDI IN:JACK** to **RS+CAL**. **This is not a global setting (is per Song Project)**

C. Clock Button

VII. C.

The [CLOCK:/1] QB can be selected to set the modular input clock division at input. This can be handy if the modular clock is faster than 1/4 measures. This setting can be set for each Song Project and is saved along with the project. Under the [CLOCK:/1] QB are the internal clock settings to set the BPM and tune on the internal clock.

Playing Sequences:

If the "P" (play) Button is pressed while there is no clock source, the adjacent LED will flash to indicate "Armed for Play". Once there is a clock the Play List and Sequences will begin. This clock can be from 3 different sources...

Clock Sources:

Modular Clock: Clock from CLKin Jack
MIDI / LINK Clock: Clock from MIDI source (sender must have MIDI clock active)
BPM Clock: Internally set BPM 40 - 999 default = 120 BPM (Under [CLOCK:/nn] QB)

Clock Priority:

In the case of multiple clocks, which clock takes priority. Here are some scenarios:

BPM Clock + USE INTERNAL CLOCK:N	Modular Clock or MIDI clock required. Which ever clock exists first will be used. If one is removed, the other will take over. Clock out only sends while MIDI clock is in control. This to free jack up to be a CV input when used with modular clock.
BPM Clock + USE INTERNAL CLOCK:Y →Modular Clock	Modular Clock can override, will restart Song. Once modular clock is removed, will restart with internal clock again. MIDI clock cannot override internal if "Y" (yes) Clock Out pulses with Beat Clock (4/4) while internal clock is used.
BPM Clock + USE INTERNAL CLOCK:N →MIDI / LINK Clock	Modular Clock must be removed for MIDI or LINK clock to become priority. If MIDI Clock started while has priority, the beat count display will always match. Clock Out pulses with Beat Clock (4/4)
BPM Clock + USE INTERNAL CLOCK:N MIDI Clock <u>and</u> LINK Clock	Don't use MIDI and LINK clock inputs together as they will add and cause issues!
BPM Clock + USE INTERNAL CLOCK:N → Y	Turning on Internal Clock while another clock source is in focus will not change the clock. The other source must be stopped before internal clock starts.

***These transitions will restart Song / Play List if playing.*

CLK out:

If not being used as a CV input, and the clock input source is not CLKin, the CLKout jack will output a 4/4 clock pulse. As with the modular input clock, pulses are indicated by the amber LED.

The CLKout (CKO) jack's function and direction, (Clock Output / CV Input / Auto) options can be set under the [MIDI PUSH] QB. (See [MIDI PUSH sect. VII. A.1](#)) "Auto" is the default and switches to become an input when a modular clock is used.

Notes on Clocking:

Speed!

As the Sequarallel is less like a simple TTL sequencer and more like a computer, there are time-outs and intelligent switching controls to make clocking the Sequarallel flexible, low latency and fluid. Because of this, extremes beyond expected rates won't be tolerated well.

The modular clock input can be at audio frequency, but must be divided down to bring to a reasonable step rate. The main reason is MIDI bandwidth limitations. The buffer will bottle-neck and notes may be missed and possibly hang, controls will be skipped, and your synth may crash... the results probably won't be pleasant!

Pulse Width / train

The Clock input can detect a very short pulse (<5uS) and switches at approximately 0.7V so can be clocked with non-pulse signals like an LFO sine/triangle. The pulse train must be relatively even though!

The clock rate can be adjusted up or down but if the rate changes by more than 50% from one clock to the next, a reset will be called. All in all it tracks a varying clock quit well.

Swing!

Clocking in a swing or shuffle will work, but because of acquisition / calc delay is a poor way to get swing in the Sequarallel. The SongFX Swing swings the entire module -including MIDI clock output if selected, (see [SETTINGS→SWING CLOCK:YES](#))

That said, a less continuous pulse train can yield some cool rhythmic results! (especially if used with swing)

One final word on Swing. Keep in mind that recording Layers and TRAX with a heavy swing setting in a [SONG FX] without matching the swing in your playing may result in a reverse shuffle once the Swing setting is cleared. I discovered that my piano playing had a lot of swing quite by accident once zeroing the swing setting!

D. Transpose Button

VII. D.

The [TRANS:+nn] QB Button is to quickly adjust the global pitch in semitones by up to +/- 48. This is also one of the few panel controls that can be recorded with Automation QB. In this manual this is called the "master transpose". Under this QB you will find option to opt-in various sequencers and inputs for transposing. Also SongFX scale and transpose for MIDI input can be set here. Press & hold on the transpose QB to open these settings:

▶LAY+SONG:	YES	Transpose setting will include Layer & Song Loops
▶TRAX:	YES	Transpose setting will include TRAX Trackers
▶MIDI IN:	YES	Transpose setting will include any MIDI input
▶LINK IN:	YES	Transpose setting will include any LINK input
▶CV IN	YES	Transpose setting will include any CV → Notes input
▶RANGE:	+48	Set maximum range to adjust transpose from +/-1 to +/-48 semitones
▶DRUMS BLOCK:	YES	Protect drum notes (on percussion channel) from master transpose
▶:SONG FX:		
▶ TRANSP MIDI IN:NO		Allow Song Loop's FX bundle's Transpose to modify any MIDI input.
▶ SCALE MIDI IN: NO		Allow Song Loop's FX bundle's Scale to modify any MIDI input.
▶:EXIT:		Exit this menu. Can also hold enc to exit.

E. Select Bus Button

The Sequarallel has the PSU ribbon Select bus capabilities to be a master or slave. Press and hold QB to enter settings displayed as follows:

▶SELBUS:nn	Select Bus State #, same as in QB		
▶DIRECTION:xx	Master, Slave, Auto, or none. Auto assumes master or slave, but won't send on Song project Load.		
▶SLAVE FUNC:SONG SEL	As Slave, what to do: Load Song Project or REM: control any parameter in Sequarallel (see below)		
▶SEND SELBUS:xxxx	Sets version of select bus message to be sent		
TYPE1	Original Select Bus protocol	re: Make Noise Rene (PC)	c.2014
TYPE2	Modified Select Bus protocol	re: Preset Protocol (CC→PC)	c.2016
BOTH	Type 1 and Type 2 combined	(default)	
MERGE	Special: MIDI Output Channel 1→ Select Bus + BOTH, Proprietary SysEx (SDS)		
▶SB STATE SAVE:NO	Click this and set to YES to send a State Save for the Selected SelBus#.		
	<i>*All parameters except REM+/-nnn and SELBUS:nn are saved globally.</i>		

1. As Master

As a master, the Sequarallel will send the Select Bus # visible in the [SELBUS:nn] QB on Song Project load or power-up. The Select Bus# is also sent when [SELBUS:nn] QB value is changed from the panel, via MIDI Remote (if configured to) and by Play List *PLFX* enabled blocks. (see [PLFX*1])
PLFX is a quick method to change SelBus enabled modules on the select bus for certain Play List groups, sequences etc.

2. As Slave

The Sequarallel recognizes both Select Bus protocol and responds to the following:

- State Select	Loads Song Project 00 to 61 (62, 63 ignored)
- State Save/All	Executes a Project Save (10 second silent save if playing, halts for 2 seconds if not playing)
	*Warning: If the Select Bus# is different from the Song Project#, then that # will be overwritten!
- SelBus→Remote Note	Responds to Remote inputs as does MIDI/LINK inputs, any configured (learned)

Click on SLAVE FUNC: and select REM: to select an offset to use the [REMOTE:nn] QB's Remote Notes.

For Example: if set to +000, Select Bus #0 would execute Remote Note 0, Select Bus #1 would execute Remote Note 1 etc. up to Note 63. The offset can be +/- 127 and will use Remote priority setting (Song:nn / Global rules). (Negative result ignored)

See [Sect. V. A. \[REMOTE:nn\]](#) for more on setting Remote Notes for Song Project or Global use.

This setting is remembered for this Song Project, but will be ignored if the SLAVE FUNC: is set to SONG SEL

3. As Auto

Select Bus Direction set to Auto will assume the Sequarallel is a master until detects another master, at which point will become a slave. Master/Slave status is remembered globally, so Song Projects can be loaded. On power-up and loading, there will be no select bus sent, but if the [SELBUS:nn] QB is changed, will send the new value. If the select bus has another master, if the Sequarallel's [SELBUS:nn] QB is changed, will resume being a master.

Select Bus Clock?

This feature has been implemented in hardware, but not yet in software. This may be used for system sync and Active Sensing with all Accord series modules in the future.

** Check out the tutorial video for Select Bus feature at <https://www.youtube.com/watch?v=urwwbxxrhic>*

F. SAVE Button

VII. F.

The SAVE: QB must exist always as is used to save Song project edits, delete songs, and access Global Settings. Press the SAVE:INI QB to open & scroll down the drop-down list of QB's after it.

1. [Save: Edit]

This QB will save the currently loaded Song Project along with any modifications you have made to it. Select the SAVE:EDIT QB, then select "yes" and click to enter.

- If the Sequarallel is not Playing at this time, the Song Project is dumped immediately, momentarily stalling the module.
- If the Sequarallel is Playing at this time, then the Save will be distributed over the next 10 seconds.

* Note: Try not to make any settings changes within this time as they might save... or not!

2. [Save: Init]ial (Song:00)

This QB is only to save, reset, or modify the initial Song:00. It will not function for any other Song Project #.

To Save the present state of Song:00:

- Select the SAVE:INI QB, then press again.
- Select "yes" then press and hold encoder for about 1 second. Displays "SAVE:SONG:00"

To Reset Song:00 to factory settings:

- Select the SAVE:INI QB, then press again.
- Select "yes" then press and hold encoder for at least 5 seconds (display will go dark with brackets showing). Displays "SAVE:INIT" then displays "SONG:00"

* Note: If encoder is not held when selecting "yes" nothing will change. This is a safety measure as Song:00 is important.

[SONG:00] Song Project Load:

This QB is to select saved Song Projects (you have probably figured this one out!) but under this QB you can edit names of Song Projects in a list, (*somewhat like punching in your name in the video arcade in the olden days, if you are from that time*)

To Edit a Name-

- Scroll to the Project and click to select a letter to edit, letter is highlighted
- click and scroll to change the letter
- click to move to another letter, etc
- scroll past the line end to save.

To load one of the Song Projects, scroll the arrow to the nn: name, then double-click it.

3. [Delete] (Song Project)

This QB is used to delete the currently loaded Song Project. The deletion is permanent. You will be prompted with "SURE?" and you must select "Yes" to proceed. This QB will not delete Song:00.

4. [Save As...]

This QB is used to create a Song Project, or copy a Song Project to a new number (possibly to have an alternate version etc.) If the Song Project was started in the Initial Song:00, this is a way to save it permanently.

When selected, Save As QB will choose the first empty Song Project number. If you want a different number select it now.

Once the Song Project has been Saved, you will be directed to re-name it (under the **[SONG:nn]** QB). If not, then just scroll off of the name to exit it. At this point you can re-name other Songs or exit back to the main screen.

5. [Re-Start]

If there is ever an occasion to simulate a power cycle, this is the closest to it without powering down the rack. I personally never use this unless I just mess things up so badly and want it to go away!

Press & Hold this QB to enter the Global Settings Menu. Here there are a few items that can be set to your preferences.

a. Settings Menu

► REMOTE:DISPLAY:YES

When this is turned on, some remote control changes will update screen to indicate changes. This consumes a lot of processing power and can clutter the screen's actions when a lot is displayed, so can be disabled.

► SYSEX SAVE

This is to save a song project or all projects to a DAW via MIDI with a SysEx stream. See [next page](#) for instructions.

► SCREEN-SAVE:x min

The screen saver will dim the display to about 30% after the set time in minutes. The range is appx. 3 minutes to 60 minutes. This dimming will protect the screen from OLED burn-in over many months of use + save power. Moving the encoder or pressing any button will return display to normal brightness.

► CV IN→:MERGE INPUT

CV input (CC5, CC6, CKO) to MIDI steering: **OUTPUT**: directly to output or **MERGE INPUT**: merges with panel MIDI in to follow all configurations of MIDI in. When set to merge, the CV can be recorded just like any MIDI input.

As the jack can be configured to send MIDI Notes, Pitch Bend, After Touch or CC's, MIDI Layers can be recorded from a CV input. Similarly, Notes can be recorded to a TRAX tracker. Note that if you don't plan to use the CC jacks this way, setting to directly **OUTPUT** is lighter on the processor.

► BLOCK DRUMS PC:YES

This will turn on blocking of PC messages on percussion channel (10 by default) as some GM synths do not like it!

► SEND MIDI RESET:YES

This will allow a MIDI master reset (0xFF) to be sent upon loading a song project or pressing the **[MIDI PUSH]** QB Button. Note that some synths do nothing with a reset. Check your synths spec's for possible information.

► SEND MIDI CLOCK:YES

When the Play button is pressed, MIDI clock sync messages will be sent if this is turned on. MIDI clock is good for some synth's delay or arpeggio sync if it is set to use external clock, as well as following MIDI sequencers / FX in the chain.

► - SWING CLOCK:NO

Set to **YES** to output MIDIClock after the swing modifiers. This may be useful for swinging the Arp or delay of a synth but some don't like a varying clock. Experimentation will reveal the truth!

► - FREE RUN CLOCK:NO

Set to yes to output continuous clock based on modular clock or MIDI clock regardless of Playing or Stopped. Only once the clock input source stops, will the MIDI clock output stop. This can be useful for continuing a long delay on a synth that may switch it's clock source to internal or just stop after an input clock stops.

► NRPN:n

This selects an NRPN Preset to edit. There are up to 16 NRPN's. They can be sent from the Sequarallel by any function that can send **MIDI CC (MIDI PUSH, TRAX NoteFx, CV Input)**. To set the ►MSB & ►LSB, first select which **NRPN:nn** (0-15) you wish to edit, then scroll down to set MSB & LSB values (0-127).

► TRACK REMOTE:nn

This is the global setting for Track Remote Notes overlay. When set to "--" Track Remote is non-operational.

Set an offset, i.e. 12, 24, 36... to set the remote notes start point. 36 is a good value for most keyboards.

See [Section V. B. Track Remotes](#) for more on this remote control feature

► GATE DELAY:1

Some digital modules require a stable CV for a time before the trigger (gate) occurs. Set this higher to compensate.

b. SYSEX's

SYSEX SAVE:

This allows backup up of a Song via MIDI SysEx to a storage device (i.e. computer) for later recovery, or to share project with other Sequarallel users as the files are not large. (I may even post some Song Projects on the site!)

There are two types of SysEx Save:

- SONG:nn** Save currently loaded Song Project via SysEx
- SONG:ALL** Save All Song Projects in memory, up to 62

With a computer, the most used free software MIDI-OX can be configured to receive & save, or load & send a SysEx. A single Song Project may take 6 seconds to over 2 minutes depending on the size, while a complete dump of 62 Song Projects may take 30+ minutes.

Here's how to use MIDI-OX to save & load Sequarallel Song Projects to your DAW

Save Song Project / Dump All →

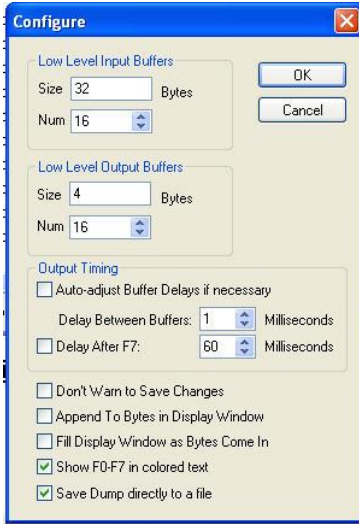

First in **OPTIONS** tab, make sure the **PASS SYSEX** option is checked (at bottom)
*** Also select MIDI Devices... to include your MIDI interface as input and output*

Under the **VIEW** tab, select **SysEx...**
This will open the **SysEx View and ScratchPad** window.

Now click the **SysEx** Tab and select **Configure...**

The window shown to the left will appear. Match the settings shown in the image. This should work with whatever MIDI USB hardware you have. If not, you could try changing buffer size settings.

Firstly, you probably want to do a back up of Song Projects you have so far, so use the following procedure:

Select the **SysEx** Tab and click **Receive Manual Dump...**
This will open the file browser for you to name the file you want to create. (below)

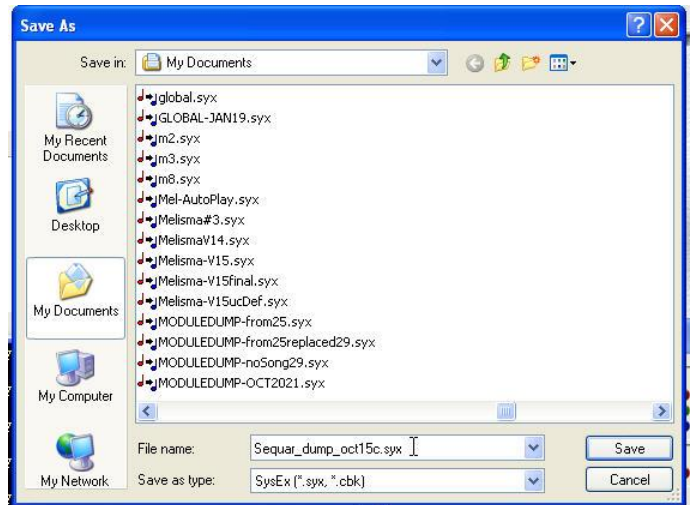
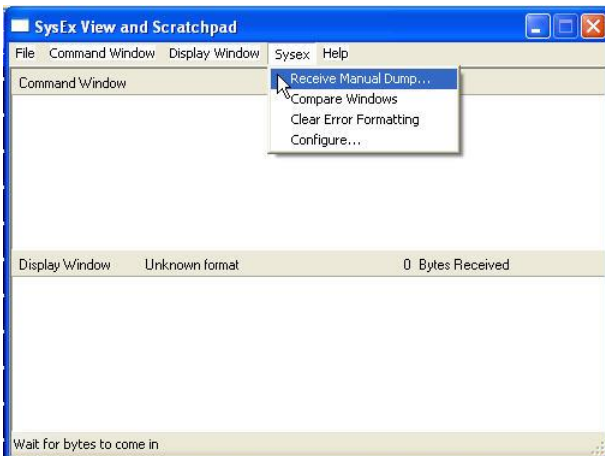

Once you have a name entered, MIDI-OX will go into a wait state.

SYSEX Save cont...

In the Sequarallel's Settings/SysEx Save:
select SONG:ALL
(or SONG:nn if you only want to save present Song Project).

If you have patched the Sequarallel's MIDI output to your DAW's MIDI input properly, the n Byte Received count should be climbing.

WARNING!!

It is super important to not click and / or drag this little window while the downloading is in progress!
There seems to be a bug in MIDI-OX that causes the Receiver to "go deaf" when mouse clicked, which will Cause data to be skipped, thus useless file.

Only click DONE once count stops for a few seconds.

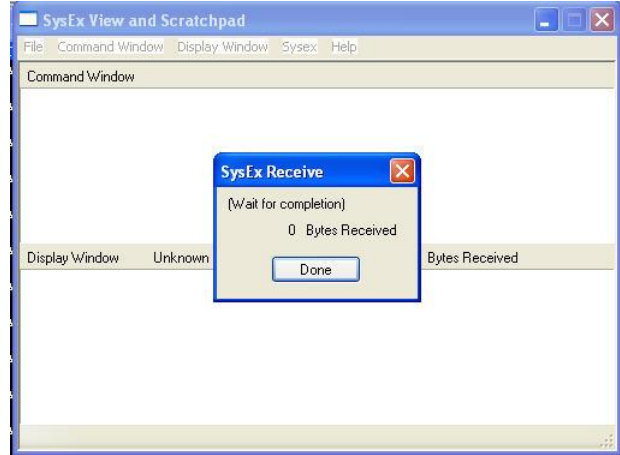

The Sequarallel will also indicate the last Song Project number to be sent in the top right over the header bar. As mentioned above, a multiple-project SysEx dump can take quite a while, so just leave it do it's thing!

SysEx Thru??

Besides sending SysEx messages, the Sequarallel will also forward SysEx received. SysEx received on panel MIDI in will be sent through to panel MIDI out. SysEx received on LINK in will be sent through to LINK out.

SYSEX LOAD:

To upload Song Project(s) back into the Sequarallel, the MIDI patch must be reversed from the DAW to Sequarallel's MIDI input jack. ** Prepare the Sequarallel by stopping any Playing, remove the Clock input and any other inputs (CC5/6/CKo)



Under the VIEW tab, select **SysEx...** This will open the **SysEx View and ScratchPad** window.

Under the **File** tab, select **Send SysEx File...**

This will open a browser window with which to select your previously created SysEx file.

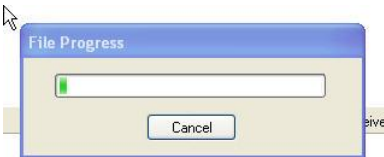

As soon as the file has been selected the upload to the Sequarallel will begin and is indicated by the File Progress window. This will close when done.

If you are loading a multi-project file then each Song Project slot will be loaded with the original number, and permanently saved.

If you are loading a single project file, then it will be loaded to which ever Song Project number is open in the Sequarallel. It must be [SAVE:EDIT] or [SAVE AS...] to be permanent. This allows songs to be placed elsewhere, i.e. "best of" or "gig" etc.

Note: Multiple Project .syx's can be changed inside a raw text editor. This is only if you know what you're doing! There will be a discussion on methods of doing this as it's kind of handy, at <http://www.freshnelly.com/sequarallel/sequarallel.htm#SUPPORT>

Summary:

If you are uncertain about your hardware MIDI-USB then try dumping and re-loading a single Song Project, and tweaking the buffers. The MIDI-USB buffer size is never listed in the specifications.

Note:

As of V.1.3. Layers can now record SysEx streams. See notes in Addendums (last page of this manual) for more.

Other SYSEX's:

Scala to MTS:

The Sequarallel can accept Scala tuning data to replace VCO tuning data selections used by a CV jack 1-4. This is accomplished by converting the .scl ratio type of format produced by Scala into MIDI Tuning Standard SysEx.

Create your own Scala at <http://www.sevish.com/scaleworkshop> and convert to MTS SysEx files with the form at: <http://www.microtonalsoftware.com/scl-scala-to-mts-converter.html>

Let's Convert Scala Files to MIDI Tuning Standard (MTS) sysex files!

Here is how to convert Scala files to MIDI Tuning Standard (MTS) sysex files. We have to select a Scala file, and add information about the actual desired pitch for the scale to anchor to since Scala files by themselves are for scales and not tunings. As they don't include the specific pitch information needed to create a complete instrument tuning, we will add that here.

- Please specify a Scala file:

Scala files have the suffix .SCL
File **chrom_new.scl** is chosen.
- Please specify the scale's starting key and the desired frequency of this key's pitch, given in Hz (cycles per second). You can type in the field or select a preset from the menu. The key given will be the point where the first note of the Scale anchors itself to a real pitch, forming a Tuning.

Middle C is C3. Concert A is A3.
- Now press this button to download your MTS sysex file:

It's important that the MTS SysEx has a "non-realtime SysEx header" (**F0 7E nn 08 01 pp [name=16 chars]...**), which is created by the above web page.

The new tuning will not be ported to the MIDI outputs (at this time) as 99% of hardware synths do not recognize the MTS SysEx, and fewer yet have beyond +/- 100 cents range. Some software synths do, but then it would be easier to use Scala direct in software with those ;)

To assign the SysEx MTS tuning to a CV jack, simply

1 - Scroll to the **[TUNE:nn]** QB, press and hold to enter it.

2 - Select the CV Row R1: R2: R3: or R4: and scroll through the names you have created, to select 1 of 8 for this jack

** If you leave the name highlighted, it will be overwritten with Scala name, if not then original name will remain.*

3 - Send the SysEx. Once completed, the name of the Scala scale will appear as a name. Name can be changed as usual.

Step 2 & 3 must be repeated for every jack you wish to use this Scale with. There will be variation from jack to jack so automatic calibration to the VCO you wish to use is recommended. ([See Sect. VII. B. 3. AutoCal](#))

** Note: Calibrating a VCO selection on a Jack will remove the Scala tuning, so needs to be re-sent.*

** See my Scala Video at <https://www.youtube.com/watch?v=XyTbFZ9jCNs>*

G. Quick-Box Edit Mode

The Sequarallel boasts the unique option to define the Quick-Boxes on the main page. User configurations can be different for every Song Project. Quick-boxes can be removed or added, duplicated and arranged in any order, however you see fit.

To enter QB Edit mode:

- press and hold the "S" button until it's LED begins to flash (about 5 seconds)
- To change a QB, scroll to it, click and select a different QB. Click to exit.
- To Add (insert) a QB, scroll to where you want to add one, click and scroll to **[ADD:]**. Click to apply. Click again to change.
- To **DELETE** a QB, scroll to it, click and scroll way down to **[DELETE]**. Click and the QB is gone.
- To Exit QB-Edit Mode, press the "S" button.

Tips *

- * Some QB's you may use often so they could exist in two places. **[:SONG FX:] Loop/FX#** can show in more than one place.
- * Keep in mind removing the **[SONG:nn]** QB will prevent you from loading any other Song Project! No **[SAVE:EDIT]** = no save.
- * Deleting a TRAX QB that exists in the Play List could cause problems, same with Layer QB's. Do this early in project.
- * The maximum Quick-Boxes on the main screen is 30.

VIII. Appendices, Specifications, Trouble-shooting

Parameter	Specification	Description
Size Dimensions	8 HP Eurorack	40.6mm x 128.5mm x 41mm (39mm depth)
Weight Shipping	.19 Kg	Including packing, PSU Ribbon, 1 MIDI patch cord
Electrical Spec's		
Power Supply	+12V / -12V	+12V@90mA, -12V@30mA
Internal Voltages	+12,-12,+5,3.3,2.0	2 x 5V Regulators, 1 x 3.3V, 1 x 2.048V, 1 x 2.048V (variable ref)
Gate Outputs	4.6V @ 50mA	Gates 1-4. 10K Pull-down
Gate Output Min PW	1.0 - 2.0 mS	In Trigger Mode 1.0mS, MIDI triggered gate 2mS minimum
Clock Input	0.7 V min	10K pull-down, requires 0.7V minimum to trigger.
Clock Input min PW	4.0 uS	Shorter pulse width may be missed
Clock Output	4.6V @ 25mA	100K Pull-down
CV Output Range	-5 to +5 Volts	CC1-6 Bi=polar or uni-polar, CVout 1-4 1V/Oct -5V to +5V
CV Output Drive	50mA @ 5V	All CV outputs, CC output 1-4. CC 5&6 48mA @ 5V
CV Input Range	-5 to +5 Volts	-10 to + 10V Max. Inputs are protected but may cause PSU surge if >12V
CV Input Load	50uA @ 5V	Applies to CC5 & CC6 input mode. CKo as input: 100uA
CV→Gate Delay	1mS to 20mS	Near zero Slew. Cndx: CV Glide off, Gate→CV delay adjustable 1-20mS
Operational Spec's		
Layer Play Heads	32 Heads	Tested @ 32 simultaneous sequences, 12 with higher MIDI load
TRAX Play Heads	5 Heads	Tested @ 20 lanes on 4 MIDI channels + one 4 channel MPE (with above)
Song Play Heads	1 Head	Tested @ 6 chans. with 1/32 Sub-sequencer note re-triggering + above.
MIDI Stack Sng/Lay	32 notes	Simultaneous Notes On over Song + Layers. Variable until needed.
TRAX Stack (Ring)	64 notes	Simultaneous Notes On from TRAX Trackers incl. Echo notes.
CV To MIDI (CC)	< 10mS	Direct CV input to MIDI CC / PW output (varies with density of stream)
MIDI Out Rate	1040 mess/Second	Panel MIDI Out: Mess = 3 bytes (note on, Note off, CC)
LINK Out Rate	1040 mess/Second	LINK MIDI Out: Mess = 3 bytes (note on, Note off, CC)
Select Bus TX	CC16 & PC types	Sends Make Noise & Malekko messages. Select either/both in SB settings
Select Bus RX	CC16 & PC types	Recognizes either Make Noise or Malekko original formats.
MIDI In Buffer	64 bytes	* Standard serial buffer space for panel MIDI in
MIDI Out Buffer	256 bytes	Custom Ring Buffer for heavier stream
LINK In Buffer	64 bytes	* Standard serial buffer space for Backplane MIDI in
LINK Out Buffer	64 bytes	* Standard serial buffer space for Backplane MIDI out
Maximum's		
Max Song Projects	62 Song Projects	This includes Song:00 which is usually for user to make initial settings
Max MIDI Song Size	197,632 bytes	This area is shared with Layers. This assumes all 40 TRAX are used.
Max Song Record	~22 Minutes	An average. This can vary drastically with slider controls / Pitchbend etc.
Max Song Loops	17	Also 17 SongFX but assignable to any Song Loop
Max Song Loop Size	999 measures	1 Loop.
Max TRAX Steps	64	With 4 lanes full, up to 256 "notes" per tracker (echo's not included)
Max TRAX NoteFX	320 Bundles	If all 8 FX bundles used for all 40 Trackers.
Max MIDI Throughput	~6.2KB / Second	Cndx: Combined Panel MIDI Out & LINK out
Max Play List Blocks	704 Blocks	Including Song, Layers, TRAX, and Automation tracks
Clocking		
Clock Input Div.	/ 96	And division from /1 to /96
MIDI Clock Rate	24 PPQN	Can be used with 96PPQN but Song measures will be 1/4 size.
TRAX Clock Range	/96 to X8	Clock time per Tracker step. Default is x 2
Max Clock Input Rate	~1000Hz	Tested at /96 Clock
Internal BPM Range	40 - 999 BPM	Sources from internal clock. Rates >500 BPM may overload MIDI stream

Sequarallel MIDI Implementation Chart

Function...		TRANSMITTED	RECOGNIZED	REMARKS
Basic Channel	Default Changed	1 1 - 16	1 - 16	
Mode	Default Message Altered	x x *****	Mode 3 x	
Note Number	True Voice	O 0 - 127	0 - 127 0 - 127	Song Record: Note 121 is special Loop Markers
Velocity	Note On Note Off	O 1 - 127 O 1 - 127	O O	Note Off 9n V=00 is changed to 8n V=64
After Touch	Key's Channel's	O as Recorded O as Recorded	O O	TRAX Record does not recognize AT
Pitch Bend		O	O	
Control Change	0 6 7 10 11 32 38 64 91 93 100 101	O MPV O PW O MPV O MPV O MPV O PW O MPV O MPV O MPV O O	x (Except Remote Control or recording)	Banksel MSB Data Entry Volume Pan Expression Banksel LSB (Bend Range) Data Hold Pedal (=0) Effect Depth Stereo Chorus RPN LSB RPN MSB
Program Change	True#	O 0 - 127	O 0 - 127	Optionally Blocked on Drums Channel (10 def)
System Exclusive		O	O	Also Passed to Output
Common	Song Pos Song Sel Tune	O * x x	x * x O **	* As recorded if exists. ** MTS via SysEx
System Realtime	Clock Command	O Start, Stop	O Start, Stop, Continue	Modular Clock ↔ MIDI Clock (24 PPQN)
Aux Messages	Local All Notes Off Active Sense Reset	O O x x	O x O x	Active Sensing ignored and not recorded or sent on
Notes		MPV = MIDI PUSH VITALS PW = (CC06, CC38) Sent to configure Pitch Bend Width MPE: Zone 0, 1 sent. Zones sent have 4 notes if origin is Sequarallel, Records Full zones. Mode 3 : OMNI OFF, POLY		O = Yes, x = no

Remote Control Implementation

VIII...

This is a list of All parameters that can be adjusted via Learned Universal Remote Control on the Remote Channel using MIDI CC's or MIDI Notes. Particulars are listed for each where required; empty cell does not mean unimplemented.

Parameter	Remote Via CC (& Description)	Remote Via Note
MASTER TRANSPOSE	Centered = 64. Range = +/- 48 so 16 to 112	Note held returns to prog. entry before adjusted
CLOCK MASTER DIV	0-127	"
SELECTBUS BUTTON	0-127, 0-63, 64=0,65-127	"
--SONG LOAD-->	0-61	1 shot
LOOP ON/OFF		Toggles, off if held
JUMPTO	0 - 63 (ROW), 0,1-31 = Group 1,1 - # of PL Groups	Note held returns to prog. entry before adjusted
CV MODE SELECT		"
CV MODE:n ORDER		"
TUNE CV MASTER	+/- 99 over full range, 64=centered	"
CLOCK INTERNAL?	0 - 63 = NO, 64 - 127 = YES (absence resume)	"
CLOCK SELF BPM	0 -127 = 60 BPM to 187 BPM (CCval + 60)	"
JUMPTO:ROW/GROUP	0 - 63 = ROW, 64 - 127 = GROUP	"
SONG FX QB & Menus		
SONGFxnn TRANSPOSE	(menu)Centered = 64. Range = +/- 48 so 16 to 112	Note held returns to prog. entry before adjusted
SONGFxnn MINLOOP	Minimum Loops: 0-127	"
SONGFxnn MAXBARS	Max Bars in Loop: 0-127 (should be shorter or =)	"
SONGFxnn MIRROR	Mirror Note 0-127. 0 = off	"
SONGFxnn MIRRLOW	Lowest Note to Mirror 0-127. Def=24	"
SONGFxnn MIRR HI	Highest Note to Mirror 0-127 Def=84	"
SONGFxnn SUBxSIZE	SongFx SubSeq Size: Range / 14 + 2	"
SONGFxnn SUBxDIVIDE	SubSeq Step Time: Range / 6 (1/32 - 1/1)	"
SONGFxnn SUBxVELOCITY	SubSeq Velocity ducking: minus 0 to 127	"
SONGFxnn SUBxLENGTH	SubSeq Note Length Mod: 1%-150% over range	"
SONGFxnn SUBxLIMIT	SubSeq Note Highest Limit 0-127	"
SONGFxnn SUBSELECT x	SubSeq# Select 1-4 over full range (/ 32)	"
SONGFxnn TRANSPOSE TO	Send to none/Layer/Trax/Both range/32	"
SONGFxnn SCALE TO	Send to none/Layer/Trax/Both range/32	"
SONGFxnn SCALE DRUMS	Yes / No, Range/64	"
SONGFxnn SUBxRE-TRIG	SubSeq ReTrigger? Yes / No, Range/64	"
SONGFxnn SUBxRE-DRUM	SubSeq ReTrigger Drums? Yes / No, Range/64	"
SONGFxnn SUBxOCTAVE+1	SubSeq Add Octave? Yes / No, Range/64	Held returns to state before adjusted
SONGFxnn SUBxKILLMIRROR	SubSeq Kill Mirror? Yes / No, Range/64	"
SONGFxnn MIR OCTAVE STEP	Adjust Step in Octaves (6's) Yes / No, Range/64	Held returns to prog. entry before adjusted
SONGFx#PL CHANGE	Change SongFX# 1-17: Range/17	"
SONGFxnn -SWING-	+ Swing: 0-90% over full range	"
SONGFxnn -SCALE-	Set Scale 1-8 (user scales=4-8): Range/8	"
SONGFxnn -LIMIT-	<0-126 then >0-126 steps in two's, 64=none	"
SONGFxnn -QUANT-	Off,1/4,1/8,1/12,1/16,1/24,1/32 CCval/7	"
SONGFxnn -LENGTH	1%-100% over full range	"
SONGFxnn -LEVEL-	1%-150% over full range	"
SONGFxnn -FXSEQ-	Select Seq1-4 , Range/32	"
SONGFxnn -SMOVE-	FX-MOV 0-23 Ticks over full range	"
SONG --SOLO--	Solo On/Off Range/64	Toggles, off if held
SONG --MUTE--	Mute On/Off Range/64	Toggles, off if held
TRAX Settings, Record Settings, NoteFX		
TRXnl BOTTOMSTEP		Held returns to prog. entry before adjusted
TRXnl!BOTTOMSTEP	Editor Pop-up. 0 to 63 = step 1 to 64 - size	"
TRXnl!SEQ SIZE	Editor Pop-up. 0,1 to 64,127 = 1,1 to 64,64	"
TRXnl TOP STEP		"
TRXnl CLOCK MULT	Disables ClockDiv>	"
TRXnl CLOCK DIV	Disables ClockMult<	"
TRXnl MIN LOOPS	0,1-127 = 0,1 to 127	"
TRXnl MAX BARS	0,1-127 = 0,1 to 127. 65=Free (no limit)	"
TRXnl CV+GAT OUT		"
TRXnl MIDIOUT CHANNEL		"
TRXnl LINKOUT CHANNEL		"
TRAX RECORD CHANNEL		"
TRXnl BRIDGE SIZE		"
TRXn REC VELOCITY		"
TRXn RECNOTE LENGTHS		"
TRXn RECNOTE DELAY		"
TRXn REC KILL FX		"
TRXn REC RE-NOTE		"
TRAX RECORD CHANNEL		"
TRXn REC THRU CHANNEL		"

TRAX REC DELETE NOTES		"
TRAX REC STACK NOTES		Held returns to prog. entry before adjusted
TRAX REC CYCLE NOTES		"
TRAX REC RECALL NOTES		"
TRAX REC FUNC CC#		"
TRAX REC OFFS CC#		"
TRAX CC# SCALE ROOT		"
TRXnl NOTE #		"
TRXnl NOTE VELOCITY		"
TRXnl NOTE DELAY		"
TRXnl NOTE LENGTH		"
TRXnl NOTE FX# (NFX)		"
TRXnl NFX RANDOM SELECT		"
TRXnl NFX RANDOM RANGE		"
TRXnl NFX ECHO-REPEATS		"
TRXnl NFX ECHO-FEED		"
TRXnl NFX ECHO-TIME	(In Ticks) 0,1 - 127 = 0:01 to 5:07 (5 beats, 7 ticks)	"
TRXnl NFX CHOP-MULT		"
TRXnl NFX CHOP-CURVE	+ / - Full range = +/-15 centered at CCval=64	"
TRXnl NFX MICRO-ARP STEP		"
TRXnl NFX FINE-TUNE		"
TRXnl NFX PAN	0 - 127 = Left - Center -Right. Center = 64	"
TRXnl NFX INSTRUMENT(PC)	0 - 127 = PC 0 - 127	"
TRXnl NFX GLIDE-NOTE	0 - 127 = Glide Start Note 0 - 127 (MIDI only)	"
TRXnl NFX GLID-RATE	0 - 127 = Glide Rate (MIDI only)	"
TRXnl NFX CC1NUM	0 - 127 = Set MIDI CC# (latches this enabled)	"
TRXnl NFX CC1VAL	0 - 127 = Set MIDI CC Value	"
TRXnl NFX CC2NUM	0 - 127 = Set MIDI CC# (latches this enabled)	"
TRXnl NFX CC2VAL	0 - 127 = Set MIDI CC Value	"
TRXnl NFX N-PROBABILITY	0 - 127 = 0% to 100%	"
TRXnl NFX MAP SIZE (MASK)	0 - 127 = 1 to 16, CCval/8 + 1	"
TRXnl NFXn ARPs TRANSP.	(s=step) +/- Full Range Centered at 64	"
TRX:n SWING (SEQ) SIZE	0 - 127 = 1 to 16, CCval/8 + 1	"
TRX:n MIRROR (IN MENU)	0 - 127 = Mirror Note 0 - 127	"
TRX:n MIR OCTAVE STEP?	0 - 63 = NO, 64 - 127 = YES (for QB ctrl only)	"
TRX:n MIRROR LOW	0 - 127 = Low Note Valid 0 -127	"
TRX:n MIRROR HI	0 - 127 = High Note Valid 0-127	"
TRX:n TRANSPOSE (IN MENU)	0-16 to 64 to 112-127. CCval=64 is center	"
TRAX QB Button		
TRAX n -SOLO-	0 - 63 = NO, 64 - 127 = YES	Held returns to prog. entry before adjusted
TRAX n -MUTE-	0 - 63 = NO, 64 - 127 = YES	"
TRAX n -LIMIT-		"
TRAX n -SWING-		"
TRAX n -MIRROR-		"
TRAX n -SCALE-		"
TRAX n -TRANSPOS	Centered at 64	"
TRAX n -RECORD-	0 - 63 = NO, 64 - 127 = YES	"
TRAX n -LEVELS-	0 - 127 = Velocity Atten 1% to 100%	"
Layer QB Button		
LAYER n -SOLO-	0 - 63 = NO, 64 - 127 = YES	Toggles, off if held
LAYER n -MUTE-	0 - 63 = NO, 64 - 127 = YES	Toggles, off if held
LAYER n -APPEND-	0 - 63 = NO, 64 - 127 = YES	Held returns to state before adjusted
LAYER n -RECORD-	0 - 63 = ARM OFF, 64 - 127 = ARM ON (bars=last)	Held returns to prog. entry before adjusted
LAYER n -LEVELS-	0 - 127 = Velocity Atten/gain 1% to 150%	"
LAYER n -QUANT-		"
LAYER n -MIRROR-		"
LAYER n -SCALE-		"
LAYER n -LIMIT-		"
Layer Menus and Step Sequencer		
LAYER n -TRANSPOSE	Centered at 64	Held returns to prog. entry before adjusted
LAYn MIRROR(MENU)		"
LAYn MIR OCTAVE STEP		"
LAYn MIR LOW LIMIT		"
LAYn MIR UPPER LIMIT		"
LAYn TRANSP(MENU)	Centered at 64	"
LAYnSEQq STEPs TRANSPOS	Centered at 64	"
LAYnSEQq STEPs LEVELS		"
LAYnSEQq STEPs RETRIG		"
LAYnSEQq STEPs USE SONGFX		"
LAYnSEQq STEPs SOLO STEP		"
LAYnSEQq STEPs BARS		"
LAYnSEQq STEPs CHANNEL		"

CV Mode/ Drum Mode→CV & CC Jacks & Order Menus		
CVM:n ROWn TRIGGER?		Held returns to state before adjusted
CVM:n ROWn GLIDE-VELOC?		Held returns to state before adjusted
CVM:n ROWn GLIDE RATE		Held returns to prog. entry before adjusted
CVM:n ROWn GLIDE TYPE		"
CVM:n ROWn GLIDE NOTE		"
CVM:n ROWn MAXOCTAVES		"
CVM:n ROWn (VCO)		"
CVM:n ROWn CHANNEL		"
CVM:n ROWn LANE (TRAX)		"
CVM:n ROWn MIDI MERGE?		Held returns to state before adjusted
CVM:n ROWn LINK MERGE?		Held returns to state before adjusted
CVM:n ROWn SOURCE (A)	None / SongLoop / Layer/ Trax / MIDlin / LINKin / MIDlout / LINKout. CC range / 8, (every 16)	"
CVM:n ROWn SOURCE (B)	SongLoop#(17) Layer#/L(32) TRAX#/L(40) as direct values.	"
CV MODE SEL MENU		
CVM:n CCc SMOOTH?		Held returns to state before adjusted
CVM:n CCc ENV RATE		Held returns to prog. entry before adjusted
CVM:n CCc GATE HOLD ENV?		Held returns to state before adjusted
CVM:n CCc SMOOTH STEP		Held returns to prog. entry before adjusted
CVM:n CCc ENV RESET?		Held returns to state before adjusted
CVM:n CCc CV<CC#		Held returns to prog. entry before adjusted
CVM:n CCc VOLT RANGE		"
CVM:n CCc BIPOLAR?		Held returns to state before adjusted
CVM:n CCc FUNCTION SEL		Held returns to prog. entry before adjusted
CVM:n CCc CHANNEL		"
CVM:n CCc LANE (TRAX)		"
CVM:n CCc MIDI MERGE?		Held returns to state before adjusted
CVM:n CCc LINK MERGE?		Held returns to state before adjusted
CVM:n CCc SOURCE (A)		Held returns to prog. entry before adjusted
CVM:n CCc SOURCE (B)		"
CVM:n CCc TRIGGER SOURCE		"
ORD:n STACK RELEASE TYPE		"
ORD:n STACK REL TIME (TIKS)		"
ORD:n STACK OVERFLOW TO		"
ORD:n RANGE ROW2/3/4		"
ORD:n CYCLE DIRECTION		"
ORD:n CYCLE REL TIME (TIKS)		"
ORD:n CYCLE MIN TIME (TIKS)		"
ORD:n RANDOM ROW1/2/3/4		"
ARPEG STEP TIME	0 - 127 = 1/4 - 1/32 , CCval / 21	"
ARPEG MASK SIZE	0 - 127 = Size 1 - 16 , CCval / 8	"
ARPEG TYPE (DIR)	0 - 127 = Type(7), CCval / 18	"
ARPEG LATCHING?	0 - 63 = NO, 64 - 127 = YES	Held returns to state before adjusted
ARPEG QUANTIZE?	"	"
ARPEG CV ARP ON?	"	"
ARPEG OCTAVE+1?	"	"
ARPEG NOTE HOLD?	"	"
ARPEG MASK RESET	"	"
ARPEG GATE LENTH	0 - 127 = 1% to 200%	Held returns to prog. entry before adjusted
ARPEG MIDI CHAN?	0 - 7 = Off, chan ~ CCval / 8 (64=ch.8, 127=ch.16)	"
DRUMS LAYOUT:n		"
DRUMS TRIGGER (mS)		"
DRUMS SOURCE		"
DRUMS MERGE MIDI	0 - 63 = NO, 64 - 127 = YES	"
DRUMS MERGE LINK	0 - 63 = NO, 64 - 127 = YES	"
DRUMS JACK(1-12) NOTE		"
DRUMS =LAYOUT= (MENU)		"
PUSH QB Button Settings		
CC5 I/O DIRECTION		Held returns to prog. entry before adjusted
CC6 I/O DIRECTION		"
CC5 CV IN FUNCTION		"
CC6 CV IN FUNCTION		"
CC5 CV IN TO CC#		"
CC6 CV IN TO CC#		"
CC5 MIDI CHANNEL		"
CC6 MIDI CHANNEL		"
CKO I/O MODE		"
CKO CV IN FUNCTION		"
CKO MIDI CHANNEL		"

CKO CV IN TO CC#		"
PUSH VITALS OPTION?		Held returns to state before adjusted
PUSH PITCHB OPTION?		Held returns to state before adjusted
PITCH BEND RANGE		Held returns to prog. entry before adjusted
CHANn PC INSTRUMENT		Held returns to prog. entry before adjusted
Play List, Conditional Blocks		
CONDn TNN SELECT		Held returns to prog. entry before adjusted
CONDn TNN H-BARS		"
CONDn TNN UNTIL1		"
CONDn TNN UNTIL2		"
CONDn TNN JUMPTO		"
CONDn TNN REMOTE 1		"
CONDn TNN REMOTE 2		"
ENVn SIZE		"
ENVn TRIGGER		"
ENVn CV OUTPUT		"
ENVn MIDI CC OUT		"
P-LIST -ROW- ARM	0 - 63 = Play List All Rows to arm	Note held turns off any "armed" on track
P-LIST SONG# ARM	0 - 63 = Play List Song Track Row to arm	"
P-LIST LAY#1-4 ARM	0 - 63 = Play List Layer Track Row to arm	"
P-LIST TRX#1-5 ARM	0 - 63 = Play List TRAX Track Row to arm	"
P-LIST AUTOM ARM	0 - 63 = Play List Automation Track Row to arm	"
LAYER 1,2,3,4 RECORD	0 - 63 = ARM OFF, 64 - 127 = ARM ON	"
Parameters Not Remote Controllable		
TUNE:nn Settings	SETTINGS: All settings items.	Envelope ADSR,CV DRAW,PARAMETER,COPYFROM
All Mask Blocks (NoteFX, SongFX)	All Channel Blocks (SongFX, MIDI PUSH)	SONG:nn Settings
REMOTE QB & Settings	AUTO-REC QB & Drop-down.	RecordLayer Bars Size (must be set in advance)
LOOP Song Loop Editor/Settings		

TTL:~226

Trouble-Shooting

Problem	Solution
I hit the "P" button and Demo Song 61 doesn't play!	There needs to be a clock source. If you have a clock source (real-time beats) patch it in. If not, then press and hold [CLOCK:/1] QB and set BPM / USE INTERNAL CLOCK:YES
My VCO is out of tune at the extremes.	Use the Auto Calibration feature for a perfect alignment every time. Note that each CV jack must be tuned to it if you wish to use it in any row. Saved permanently.
My Sample Player plays random samples under Gate+CV control.	It is possible the Gate (trigger) is too early for the sampler's CV circuit (slewing). In SETTINGS , adjust the Global GATE DELAY up a couple of mS.
The Envelopes Voltage is unexpectedly low.	Check behind the [CV MODE:n] QB → JACK:CC1-6 → V-RANGE:100% For more on CC jack setups see CV MODE Settings
Faster Envelope seems lower resolution than expected.	Quick adjusted ENV RATE: >X1 in CV MODE QB skips steps. To properly adjust envelope's base speed, enter ENVELOPES Settings and select to adjust ENV SIZE:n:nn
My Envelope won't send on MIDI	In [ENVELOPE] CV OUTPUT:x must be set as uses mapping through [CV MODE] . If you prefer not to have a CV output, CC5 or CC6 can be used even if they're set to be inputs. If trigger source is from [CV MODE] , then make sure is set to correct Envelope #
I can't record a Layer on a certain MIDI Channel.	Make sure you are patched to MIDI in or LINK input. You should be able to "hear" input at MIDI out: Make sure the Channel is not Filtered out in MIDI PUSH→MIDI INPUT Check to see that the [REMOTE:nn] QB is not set to this channel (will block playback)
Transpose (Master) Seems delayed after adjusting it.	This is normal. If Playing, it will change on new bar (4/4 measure), if not playing then transpose change waits for next clock. If no clock then it is immediate.
I can't record an Automation	Make sure there is a clock source. Be certain you have MIDI / LINK input connected. Check [REMOTE:nn] channel (if not intending to automate via remote control)
I can't Calibrate a VCO	Make Sure VCO is set to a Square wave, not modulated, minimum 4 volts amplitude, MIDI LED will cycle when patched to RS jack. Make sure [TUNE:+0] setting MIDI IN:JACK: is set to RES+CAL (reset or Calibrate)
TRAX PLFX control of other TRAX is latent	If the TRAX# is higher (further right in Play List) then the TRAX(s) before it will have already started, so any FX applied will miss the first step. Try using Automation Recording or SongFX.
A Track in the Play List won't play	One block in the track must be armed to Play. Double-click on it and select [:ARM:]
Jumping (arm) to a Conditional in Play List continues playing Track	The Conditional block must have Bars set or at least 1 "HOLD UNTIL" set, which in turn sets the bars to "CN" by default, this can be adjusted down to 1 bars, but not 0. Conditionals with <u>no</u> parameters set will be stepped through immediately (bridging)
Song won't Record, or records improperly / mis-timed	If Using MIDI sequencer, there must be MIDI Play command + MIDI clocks to sync. -Make sure there is no modular clock input as Sequarallel may lock to that. If recording with Modular Clock or internal BPM, recording starts with first note. If Recording from CV input, Record begins on 1st note change or CV Gate.
CC5 or CC6 jack has no output	Jack(s) must be configured to be outputs (input is default). Go to [MIDI PUSH] menu and set CCx DIRECTION:INPUT
JUMP TO:nn QB is stuck on "G1"	Jump To function is set to select groups of Play List blocks, not rows. Open the [JUMP TO:nn] menu and set JUMPTO:ROW .
CV Input "Notes" won't work	Make sure neither of the other two CV inputs are set to be a Gate, unless you intend to use a Gate input. If no inputs are set to Gate, CV input must change by at least .08 Volts within 4 mS to trigger a MIDI note. BTW This mode is better with scales (slew errors)
CV Input "Notes" won't record	Make sure in [SETTINGS] ([SAVE:EDIT] drop-down) that CV IN▶xxx is set to MERGE INPUT, which will merge CV Notes as MIDI instead of directly to MIDI out.
CV Input "Notes" sometimes trigger by themselves	"Notes" uses slight voltage changes to trigger, which could also be from a noisy module nearby or noise on PSU ribbon. Use a CV "Gate" on one jack to resolve.
Can't enter Calibration Mode	In [TUNE:+0] QB make sure MIDI IN:JACK: is set to RES+CAL (reset jack)
Recording song is changing parameters in the Sequarallel	Make sure that the remote channel isn't a channel in the song, or set [REMOTE:NO]

Addendums:

Due to present unknown factors in the final design of expansion module(s) the firmware *does not yet* include any drivers for said expansion. This means that if you purchase an expansion module in the future, you must use a computer to do an update via USB. This can be done with Windows or Mac OS, Arduino IDE, and download the update that will be posted at: <http://www.freshnelly.com/sequaralle/sequaralle.htm#SUPPORT>

Also check the site from time to time for "High Points" <http://www.freshnelly.com/sequaralle/sequarhighpoints.htm#highPoints> which lists some of my own (and possibly other's) experiences with using the Sequarallel and patching etc.

Song 61:

If you're just starting out, or want to import some pre-made TRAX loops (drums) then check out the demo Song 61! Using [ADD NEW] in the play list to create a new TRAX block, then double-clicking it and selecting [ADD NEW] again to import to the TRAX Letter you can access TRAX patterns from other Song projects. Scroll up to Song 61 & hit play to audition them. If you accidentally destroy Song 61 (by saving modifications, or deleting it) you can download the sysex zip from the support section shortcut to Song Projects at <http://www.freshnelly.com/sequaralle/sequaralle.htm#SUPPORT> and upload it to the Sequarallel via MIDI using MIDI-OX or other software. (Song 61 may be updated occasionally as well!)

Song Project Data Base:

To assist in learning the Sequarallel there are example Song Projects you can download and import via MIDI SysEx (MIDI-Ox) along with your projects (follow instructions on webpage) at <http://www.freshnelly.com/sequaralle/sysex.htm>

TRAX Delete:

When a TRAX QB is Deleted (last TRAX QB only) only the QB is removed, the data stays intact, but all of it's Blocks in the Play List are removed. On the other hand, when a Layer QB is Deleted, all of the data is erased.

TRAX "Erase" will clear the presently playing (or armed) grid, but leaves the settings intact. This is a shortcut to the editor method, selecting FILL, then DELETE, then double-clicking upper left corner of grid to delete.

MIDI Clock 96PPQN:

Originally 96 PPQN compatibility was to be included along with the standard 24 PPQN. With the addition of many alternate menu functions and considerations thereof, then realizing this was to accommodate at best the Song Loop recording, it became apparent that 96 PPQN would be too complex for such a small module.

Any MIDI at 96PPQN can still be recorded no problem, but the bars (measures) displayed will be 4X the original. For the purpose of modular tweaking, being able to quantize changes, play list steps (and more) to the 4/4 beat, rather than to bars might be advantageous!

Remote Channel Pitch Bend:

The Pitch Bend on the remote channel will bend all existing MIDI channels. This will not be recorded by Layer Recorder.

New! (V1.3) Layer Clock Record *(page 13)*

If a Layer is armed to record and in record options **CLOCK:START:YES** then arming to play, record will begin on the first clock (along with Playing) without a MIDI Note or CC. As the clock may be other than a previous clock rate, it's a good idea to run the clock for a few seconds before arming to play/record or the jump to new clock rate may distort the first few note's timings.

New! (V.1.2) Layer SysEx Record

Layer can now record MIDI SysEx streams. This is experimental but fully functional. It is recommended that the SysEx(s) are in their own Layer QB so they can be made 1-shot with a conditional stop in the play list. Long SysEx's (>200 bytes) may stall play as they need to be an uninterrupted stream to conform to the MIDI standard. Most synth system SysEx's are 8 to 20 bytes so won't be a problem.

Others, like our Melisma List configurations, can be several K. If this is the case, consider placing the Layer block with the SysEx into it's own Play List group which can thus be armed and sent manually, so it isn't part of the song.

Known Issues:

TRAX Max Bars and PLFX:

With PLFX on TRAX Blocks: Because TRAX PLFX modifiers are sent just before the tracker loop point, looping early as a result of MAX BARS setting may make some timely modifications (i.e. transpose) late as notes may have already played. This also applies when resuming from a Conditional block.

Automation Track PLFX:

Normally each track can have up to 7 different PLFX bundles assigned, but the [AU] track can only have 4.

Uneven Song Recording (i.e. doesn't end on a bar):

If a Song is recorded but is terminated before the last/next bar marker, it will not loop properly. Solution : trim off last bar with [LOOP:OFF] QB's "Song End" setting. This may be resolved in a future update

After a Song Project is deleted, the [LOOP:OFF] QB appears temporarily until scrolled off of them.